

 PIONEER®

Service Manual

**CIRCUIT DESCRIPTIONS
REPAIR & ADJUSTMENTS**

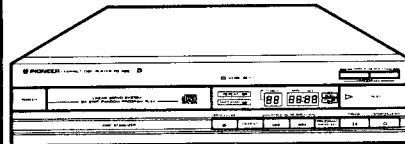

**ORDER NO.
ARP1270-A**

COMPACT DISC PLAYER

PD-X88

MODEL PD-X88 COMES IN THREE VERSIONS DISTINGUISHED AS FOLLOWS:

Type	Power requirement	Destination
HEM	AC220V, 240V*	European continent
HB	AC220V, 240V*	United Kingdom
SD	AC110V, 120-127V, 220V, 240V (switchable)	General market

*Change the primary wiring of the power transformer

- This service manual is applicable to the HEM, HB and SD types.
- As to the HB and SD types, please refer to pages 72.
- Please refer to the service manual for PD-9010X (ARP-883) about the basic function of the Circuit.
- Ce manuel d'instruction se réfère au mode de réglage, en français.
- Este manual de servicio trata del método ajuste escrito en español.

CONTENTS

1. SPECIFICATIONS	2	7. P.C. BOARDS CONNECTION DIAGRAM	17
2. PANEL FACILITIES	3	8. SCHEMATIC DIAGRAM	25
3. CONNECTIONS	6	9. ADJUSTMENTS	33
4. EXPLODED VIEWS AND PARTS LIST	7	9. RÉGLAGE	46
5. PACKING	13	9. AJUSTE	59
6. ELECTRICAL PARTS LIST	14	10. FOR HB AND SD TYPES	72

1. SPECIFICATIONS

1. General

Type.....Compact disc digital audio system
 Usable discsCompact Disc
 Signal format.....Sampling frequency: 44.1 kHz
 Quantized bit number: 16 bit linear

Power requirements
 European models a.c. 220 Volts~, 50/60 Hz
 U.K., Australian models..... a.c. 240 Volts~, 50/60 Hz
 U.S., Canadian models.....AC 120 V, 60 Hz
 Other models..... AC 110/120 – 127/220/240 V
 (switchable), 50/60 Hz

Power consumption.....18 W
 Operating temperature.....+5°C - +35°C
 Weight.....4 kg (8 lb 13 oz)
 External dimensions360(W) x 315(D) x 75(H) mm
 14-1/4 (W) x 12-7/8 (D) x 3-1/8 (H) in

2. Audio section

Frequency response4 Hz - 20 kHz
 (±1 dB)

S/N 92 dB or more
 Dynamic range 92 dB or more
 Channel separation 85 dB or more
 Total harmonic distortion.....0.01 % or less
 Output voltage 2.0 V ± 0.5 V
 Wow and flutterLimit of measurement
 (± 0.001 % W.PEAK) or less

Number of channels2 channels (stereo)

3. Functions

- Play
- Pause
- Manual search
- Programmed playback
- Track search
- Programmed repeat
- Direct track search
- All track repeat
- Timer start

4. Accessories

- Output cable1
- Control cord1
- Operating instructions1

NOTE:

Specifications and design subject to possible modification without notice, due to improvements.

2. PANEL FACILITIES

FRONT PANEL

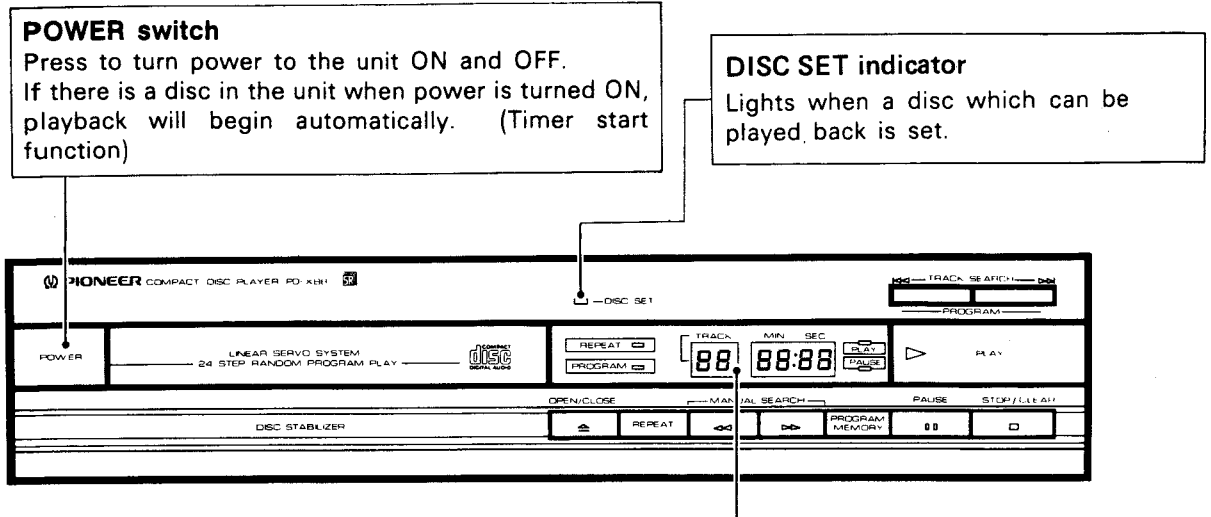

Indicators			
REPEAT	: Lights during repeat play.	MIN	: Displays the playback time in minutes.
PROGRAM	: Lights after programming (after program has been memorized).	SEC	: Displays the playback time in seconds.
TRACK NO.	: Indicates current track number, and track numbers within program.	PLAY	: Lights during playback.
		PAUSE	: Lights during pause mode, when playback is temporarily interrupted.

REPEAT key
Press to perform repeat playback

- If pressed during normal playback mode, all tracks on the disc will be repeatedly played back.
- If pressed during programmed playback, the programmed tracks will be repeatedly played back in the programmed order.

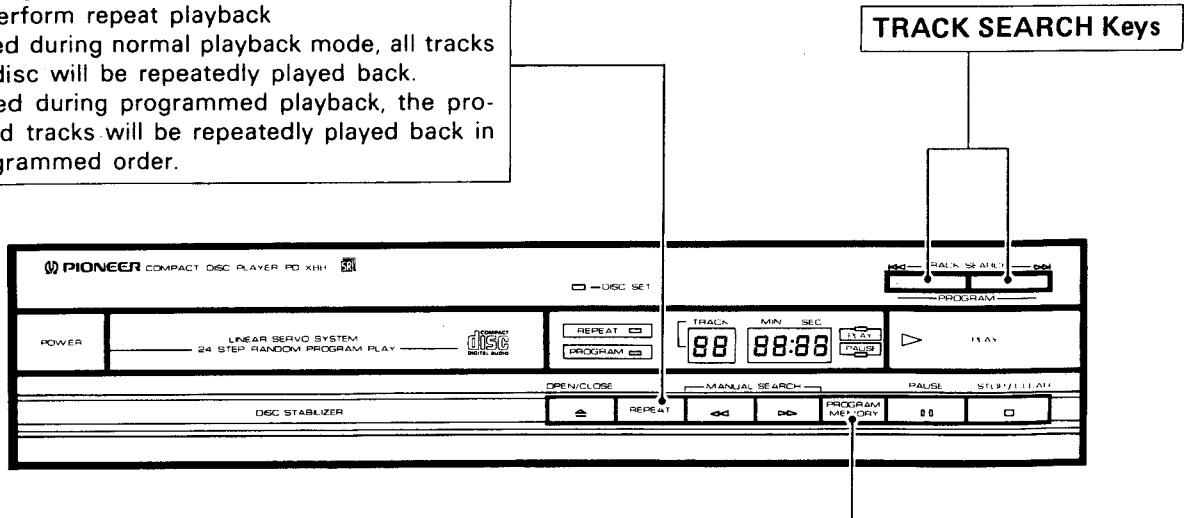

OPEN/CLOSE key

Press when you wish to eject or load a disc. Each time the key is pressed, the tray is alternately pushed out or pulled in.

Disc Tray

This is where the disc is set. When power is switched ON and the OPEN/CLOSE key is pressed, the tray is ejected forward.

To insert the tray, press the OPEN/CLOSE key, or lightly push the tray in with your finger. During play operation, pressing the PLAY key causes the tray to be inserted automatically.

TRACK SEARCH keys

When the player is in the normal play, programmed play or pause modes, these keys are pressed to search for a desired track. Pressing either key causes the player to advance to the next track, or return to the previous track.

[▶▶] : When pressed once, the disc playback advances to the beginning of the next track on the disc; when pressed continuously, the disc playback moves to the beginning of succeeding tracks on the disc. (During programmed playback, it moves to the beginning of the next programmed track.)

[◀◀] : When pressed once, the disc playback returns to the beginning of the currently playing track; when pressed continuously, the disc playback moves further in reverse to the beginning of previous tracks on the disc. (During programmed playback it returns to the beginning of the previously programmed track.)

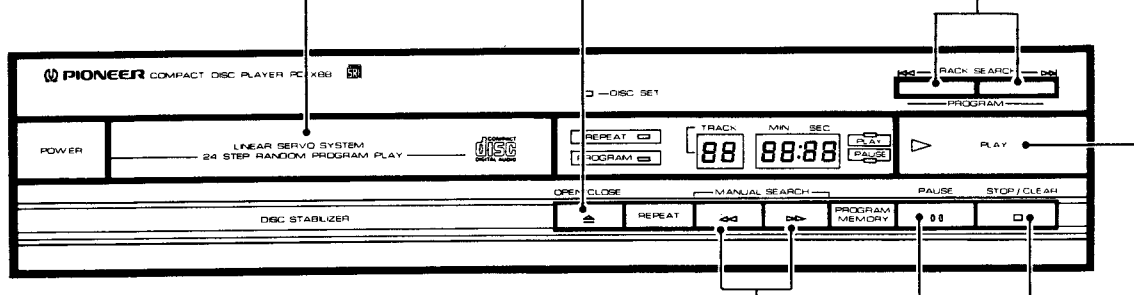

MANUAL SEARCH Keys

When the player is in play or pause modes, these keys are pressed to perform fast forward or fast backward operations, to allow manual searching. These operations are only carried out during the time either key is pressed. If pressed for more than 2 seconds, the speed increases.

[▶▶] : Fast forward operation (If fast forward operation is performed to the end of the disc "End" will be displayed and the player will enter pause mode.)

[◀◀] : Fast backward operation (If fast backward operation is performed to the beginning of the disc, the player will enter pause mode.) If these operations are performed during programmed play mode, the player will enter pause mode just before transferring to the next (or previous) track.

STOP/CLEAR Key

Press to stop playback. When pressed, the player goes into stop mode and all operations stop. Press to clear a program. When pressed during stop mode, the program stored in memory is cleared.

PAUSE key

Press to temporarily interrupt playback. When pressed again, the pause mode is cancelled and playback resumes.

PLAY key

Press to begin playback, and to cancel the pause mode.

REAR PANEL

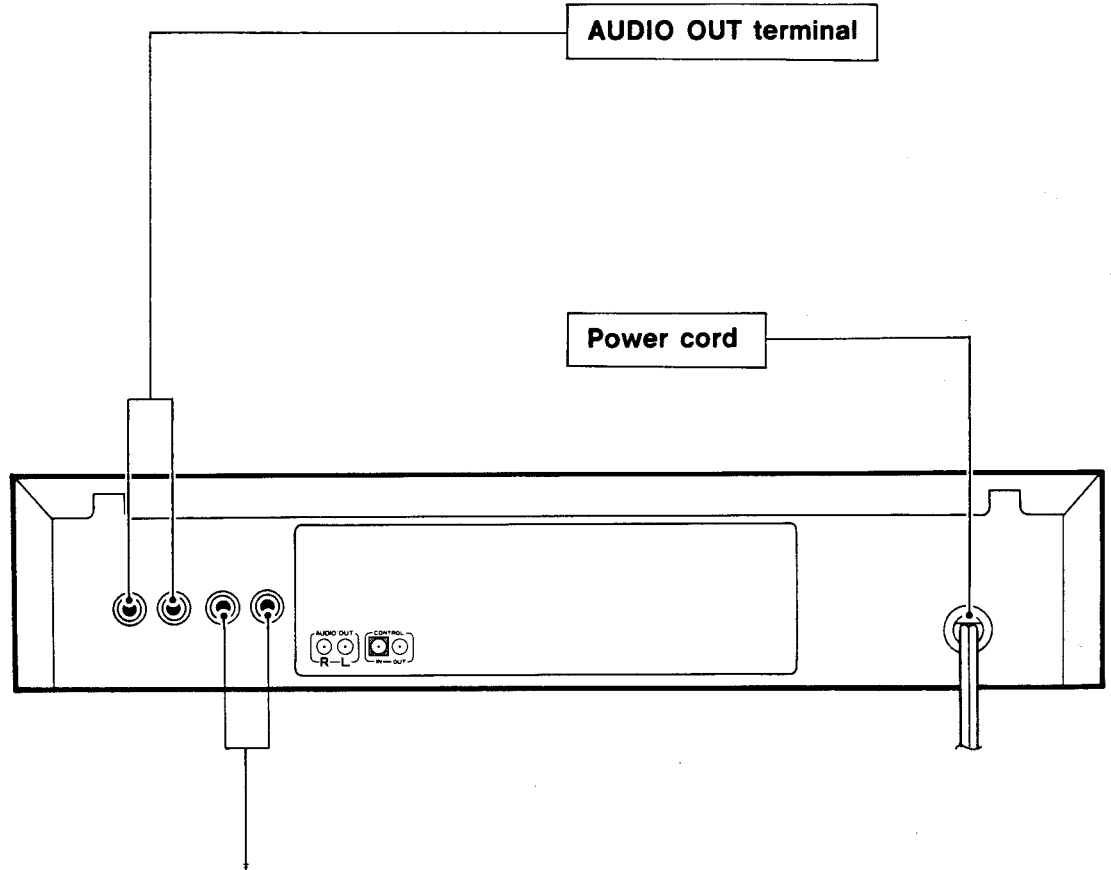

Control input terminal
 This terminal is for inputting the remote control signals relayed from an amplifier or other component with a sensor for receiving control signals from a remote controller and carrying the Pioneer  mark. Please connect to the control output terminal of the other component.

Control output terminal
 This terminal is for further relaying remote control signals to other components carrying the Pioneer  mark. Please connect to the control input terminal of the other component.

3. CONNECTIONS

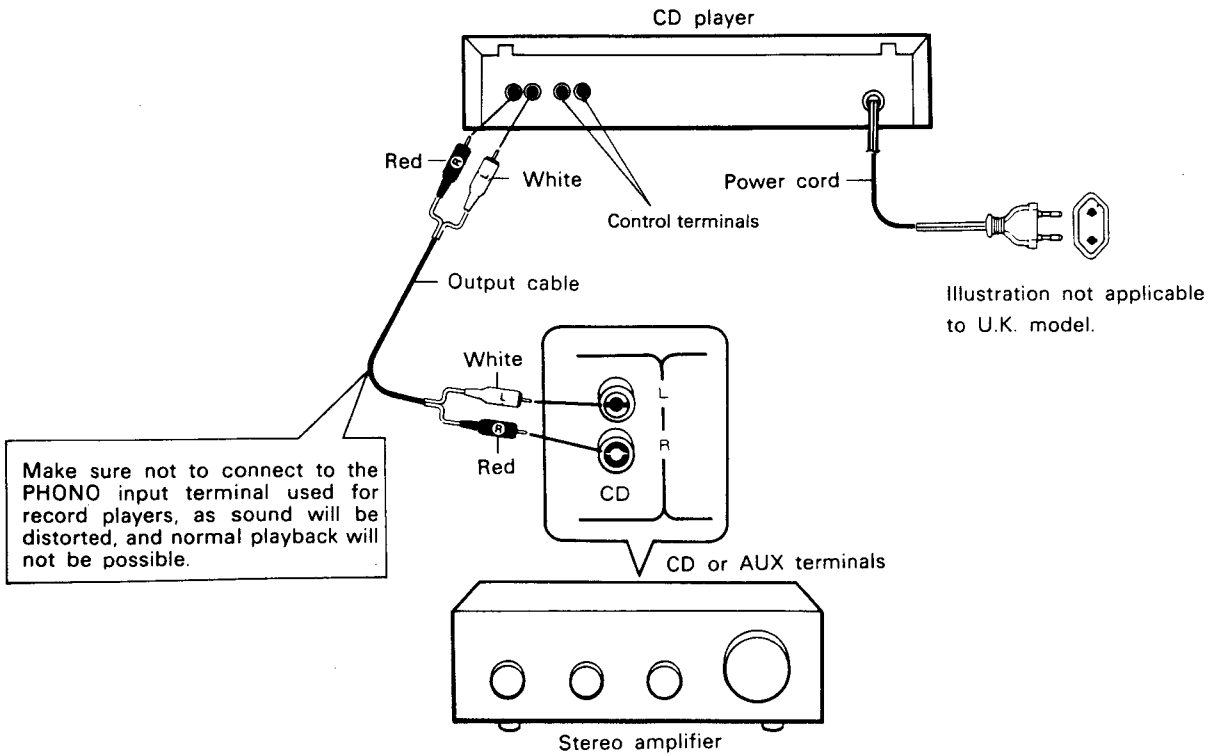

Connecting the output cable

Connect the plugs of the cable to the input terminals of the amplifier (terminals marked CD or AUX), and to the output terminals of the compact disc player.

- Connect the white plugs to the left (L) terminals and the red plugs to the right (R) terminals.
- Make sure plugs are pushed fully into the terminals.

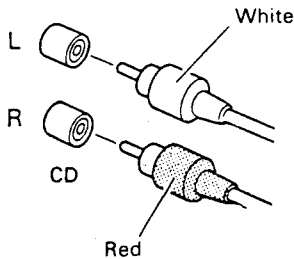

Connect the power cord

Insert the power cord plug into the auxiliary AC outlet of your amplifier unit, or into a household wall outlet.

Control Terminals

When using together with Pioneer products marked with the  mark, make connections with the supplied control cord. When this feature is not used, connection is not necessary.

4. EXPLODED VIEWS AND PARTS LIST

NOTES:

- Parts without part number cannot be supplied.
- The \triangle mark found on some component parts indicates the importance of the safety factor of the part. Therefore, when replacing, be sure to use parts of identical designation.
- For your parts Stock Control, the fast moving items are indicated with the marks $\star\star$ and \star .
- $\star\star$ **GENERALLY MOVES FASTER THAN \star**
This classification shall be adjusted by each distributor because it depends on model number, temperature, humidity, etc.
- Parts marked by "●" are not always kept in stock. Their delivery time may be longer than usual or they may be unavailable.

4.1 EXTERIOR

Parts List

Mark	No.	Part No.	Description	Mark	No.	Part No.	Description
\triangle	1.	CM-22B	Strain relief		26.
\triangle	2.	PDG1008	AC power cord		27.
\triangle $\star\star$	3.	PTT-270	Power transformer		28.
	4.	BBZ30P060FMC	Screw	\triangle ●	29.	PWZ1086	Main board assembly
	5.	BBZ30P080FZK	Screw	\triangle ●	30.	PWZ1089	Function board assembly
	6.	BBZ30P080FZK	Screw	\triangle ●	31.	PWZ1093	Transformer board assembly
	7.	BBZ40P060FMC	Screw	\triangle ●	32.	PWZ1096	Primary board assembly
	8.	PBK1002	GND plate		101.		P plate holder
	9.		102.		Switch angle
	10.	PMZ30P060FMC	Screw		103.		Label
	11.	PPZ30P080FZK	Screw		104.		Under base
	12.	PXA1024	Leg assembly		105.		Angle L
	13.	REC-434	Leg assembly		106.		Angle R
	14.	RNH-184	Cord retainer		107.		Lens
	15.	PXT1006	Function panel unit		108.		Angle (B)
	16.	PAC1019	Play button				
	17.	PAC1023	Stop button				
	18.	PAC1047	Function button				
	19.	PNW1050	Function panel				
	20.	PAC1018	Power button				
	21.	PAM1024	Window				
	22.	PNW1049	Tray plate				
	23.	PNY-366	Power SW joint				
	24.	PPZ30P100FMC	Screw				
	25.	PNA1009	Bonnet				

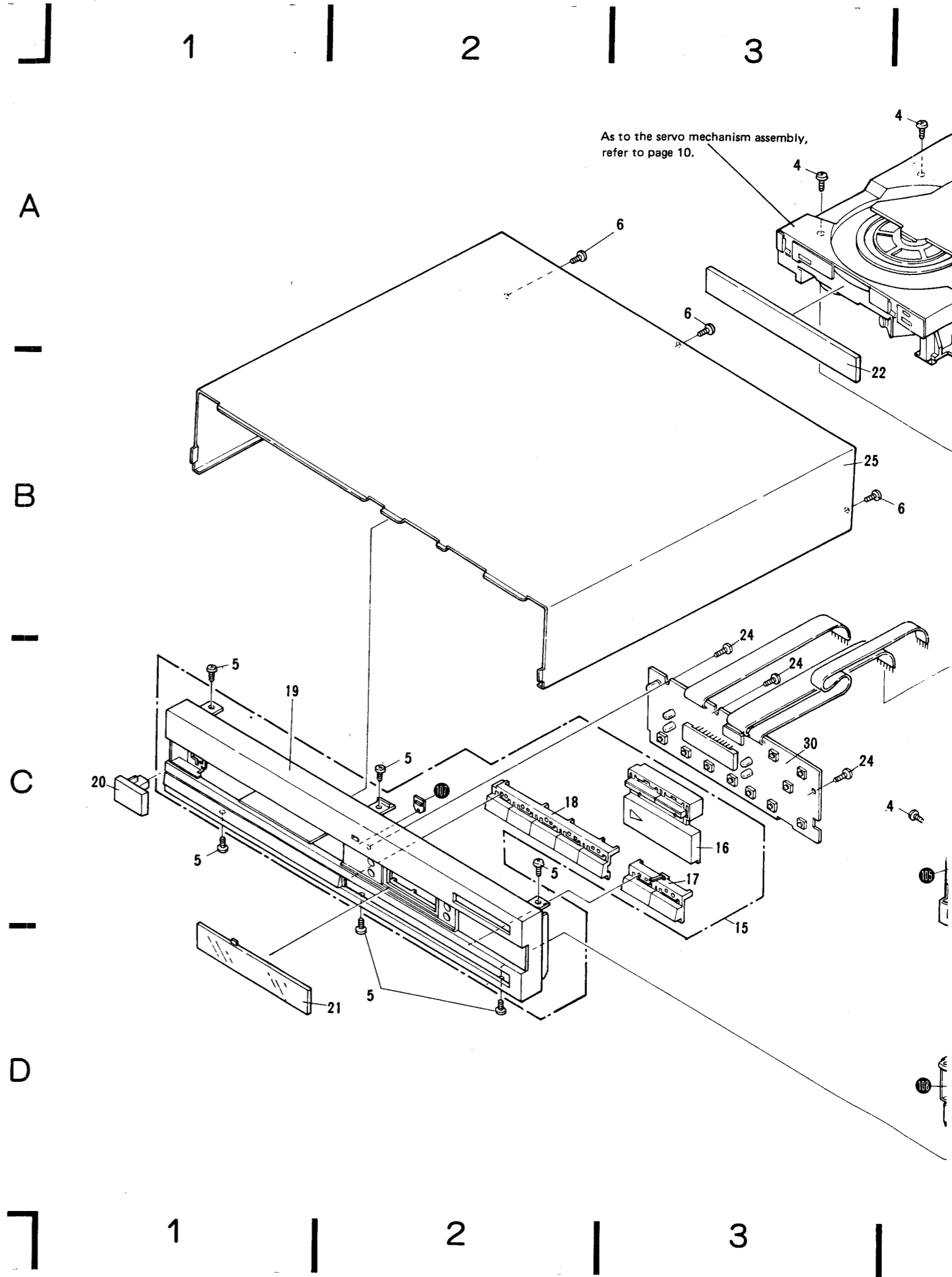

1 | 2 | 3 | 4 | 5 | 6

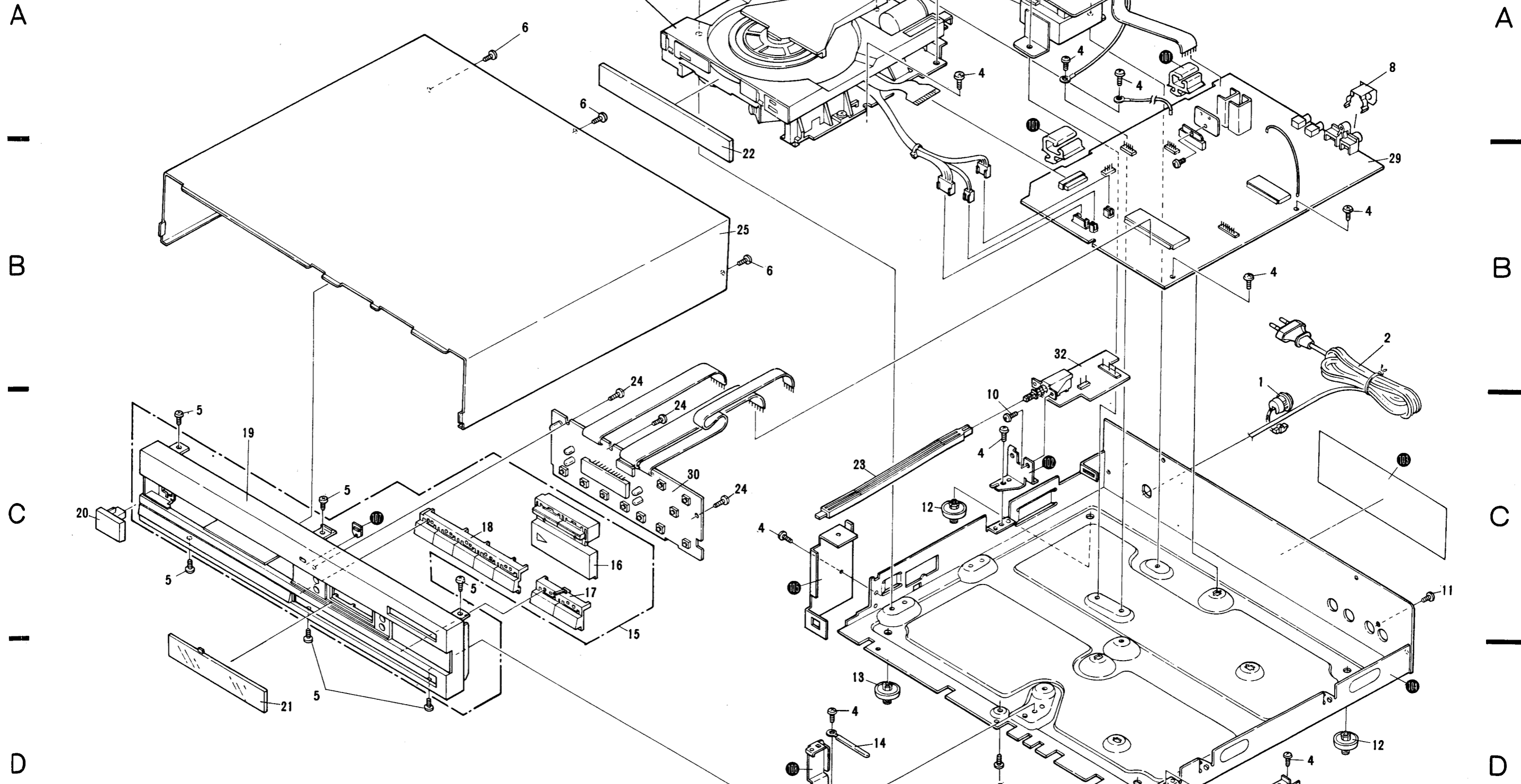

ly
sembly
l assembly
mbly

1 | 2 | 3 | 4 | 5 | 6



4.2 MECHANISM ASSEMBLY

Parts List of Mechanism Assembly

Mark	No.	Part No.	Description	Mark	No.	Part No.	Description
	1.	BBZ30P060FCU	Screw	41.	PEC-108	Binder	
	2.	IPZ30P080FMC	Screw	42.	PLB-299	Motor pulley	
	3.	PBA-213	Drive Screw	43.	PNY-602	Pulley C	
	4.	PBH-468	Clamp spring	44.	PNY-603	Gear pulley	
	5.	PBP-009	Steel ball 3φ	45.	PNY-604	Gear	
	6.	PEB-342	Belt (CARRIAGE)	46.	PNY-605	Rack	
	7.	PEC-107	Binder	47.	PNY-606	Retainer	
	8.	PLB-294	Guide bar	48.	PNY-607	Tray	
	9.	PMA20P040FMC	Screw	49.	PNY-608	Plate	
	10.	PMZ20P030FMC	Screw	50.	PNY-609	Belt cam	
	11.	PNP-394	Switch P.C. board	51.	PSN-006	Leaf switch	
	12.	PNY-499	Pulley	52.	PXM-155	Motor (LOADING)	
	13.	PNY-592	Mechanism chassis	53.	WT16D035D025	Washer	
	14.	PNY-593	Clamper holder	54.	WT25D047D025	Washer	
	15.	PNY-595	Disc table	55.	PYY-514	Motor assembly (LOADING)	
	16.	PNY-596	Spring holder	56.	PNM-058	Disc cushion	
	17.	PNY-597	Clamper lever	57.	PNW1015	Clamper	
	18.	PNY-611	Flexible holder	58.	PNM-056	Disc sheet	
	19.	PNY-612	Nut	59.	PNY-562	PU cam	
	20.	PPZ30P080FMC	Screw	60.	PBH0001	Lever spring	
	21.	PSH-019	Slide switch	61.	PBA-205	Screw	
	22.	PWY-007	Pick-up assembly	62.	PBH-455	PU spring	
	23.	PXM-154	Spindle motor	101.		Cushion	
	24.	PXM-155	Motor (CARRIAGE)	102.		...	
	25.	VNL-268	Receptacle	103.		...	
	26.	PYY-513	Motor assembly (CARRIAGE)	104.		...	
	27.	105.		...	
	28.	BBZ30P060FCC	Screw	106.		Push plate (B)	
	29.	BCZ30P080FUC	Screw	107.		PU Angle	
	30.	IBZ30P060FCC	Screw	108.		...	
	31.	PBA-188	Float screw	109.		Guide bar retainer	
	32.	PBA-214	Screw	110.		Motor pulley	
	33.	PBP-007	Steel ball 5φ	111.		Motor holder	
	34.	PBZ26P060FZK	Screw	112.		...	
	35.	PBZ30P060FZK	Screw	113.		...	
	36.	PEB-316	Float rubber	114.		Stopper rubber	
	37.	PEB-343	Belt (LOADING)	115.		Slide base unit	
	38.	PEB-344	Rubber cushion	116.		Rail cover	
	39.	PEB-347	Float rubber	117.		Loading base unit	
	40.	PEC-107	Binder	118.		Rail R	
				119.		P.U. spacer	
				120.		Servo mechanism assembly	

A

B

C

D

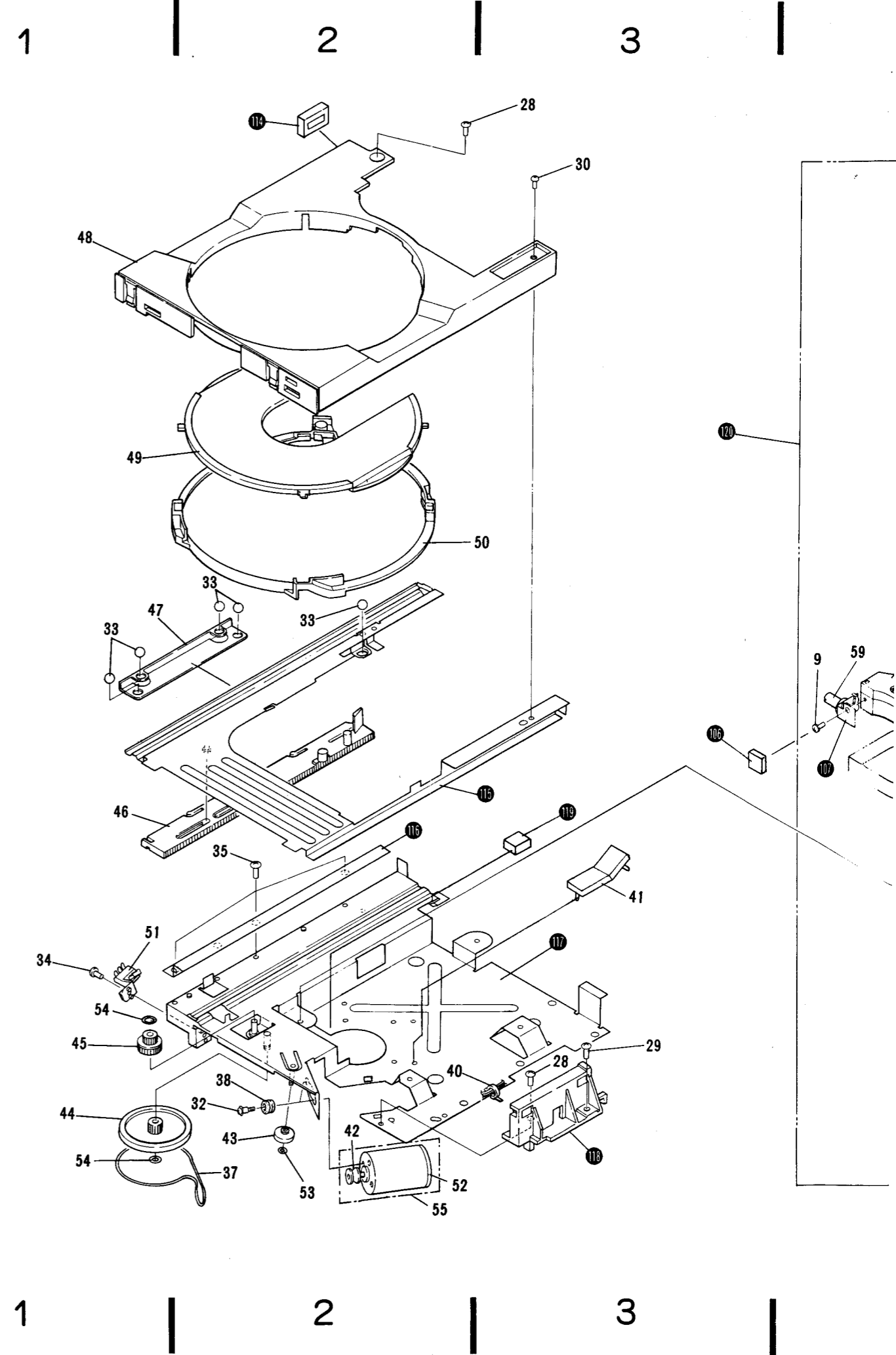

1

2

3

4

5

6

A

B

C

D

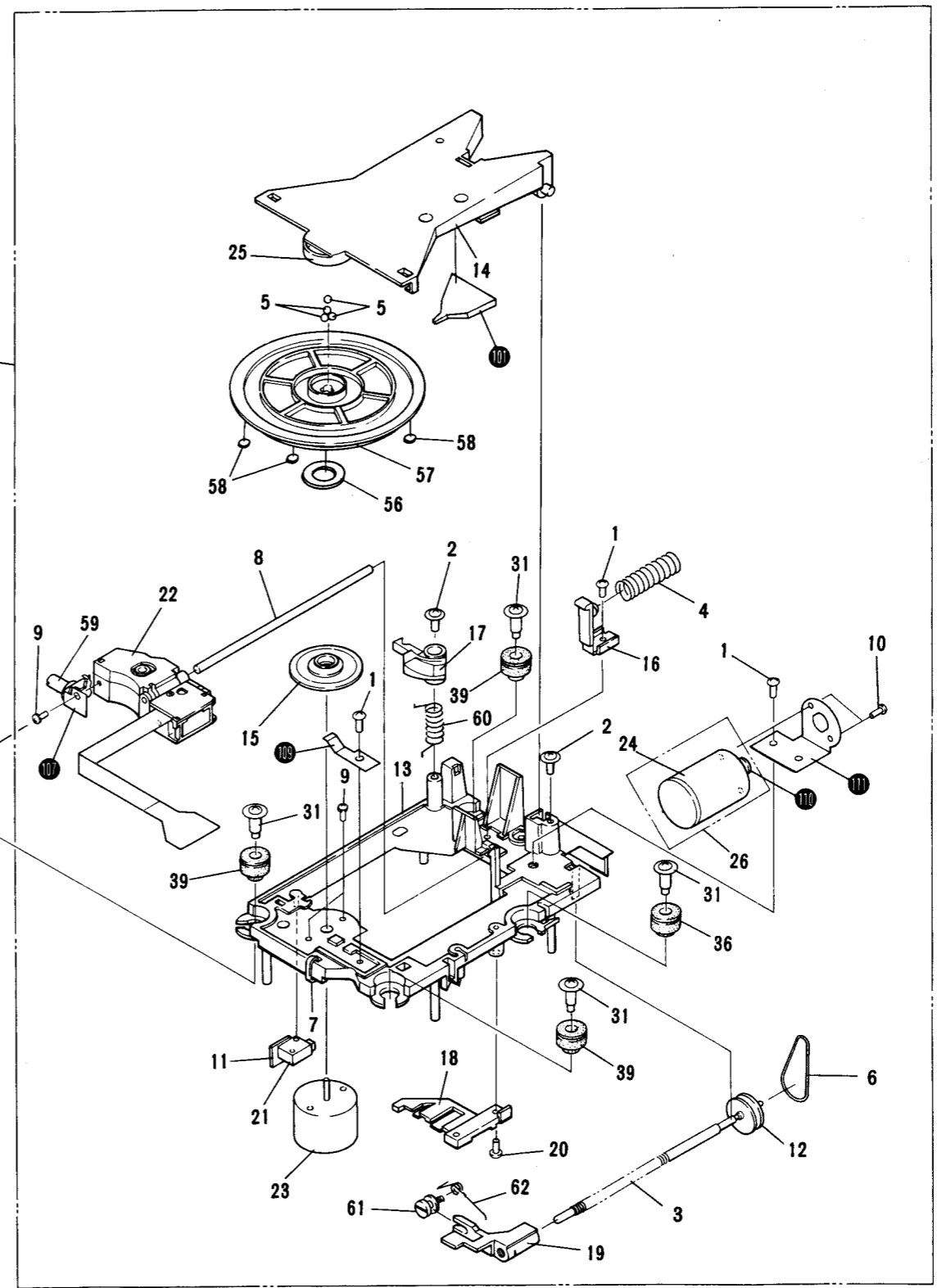
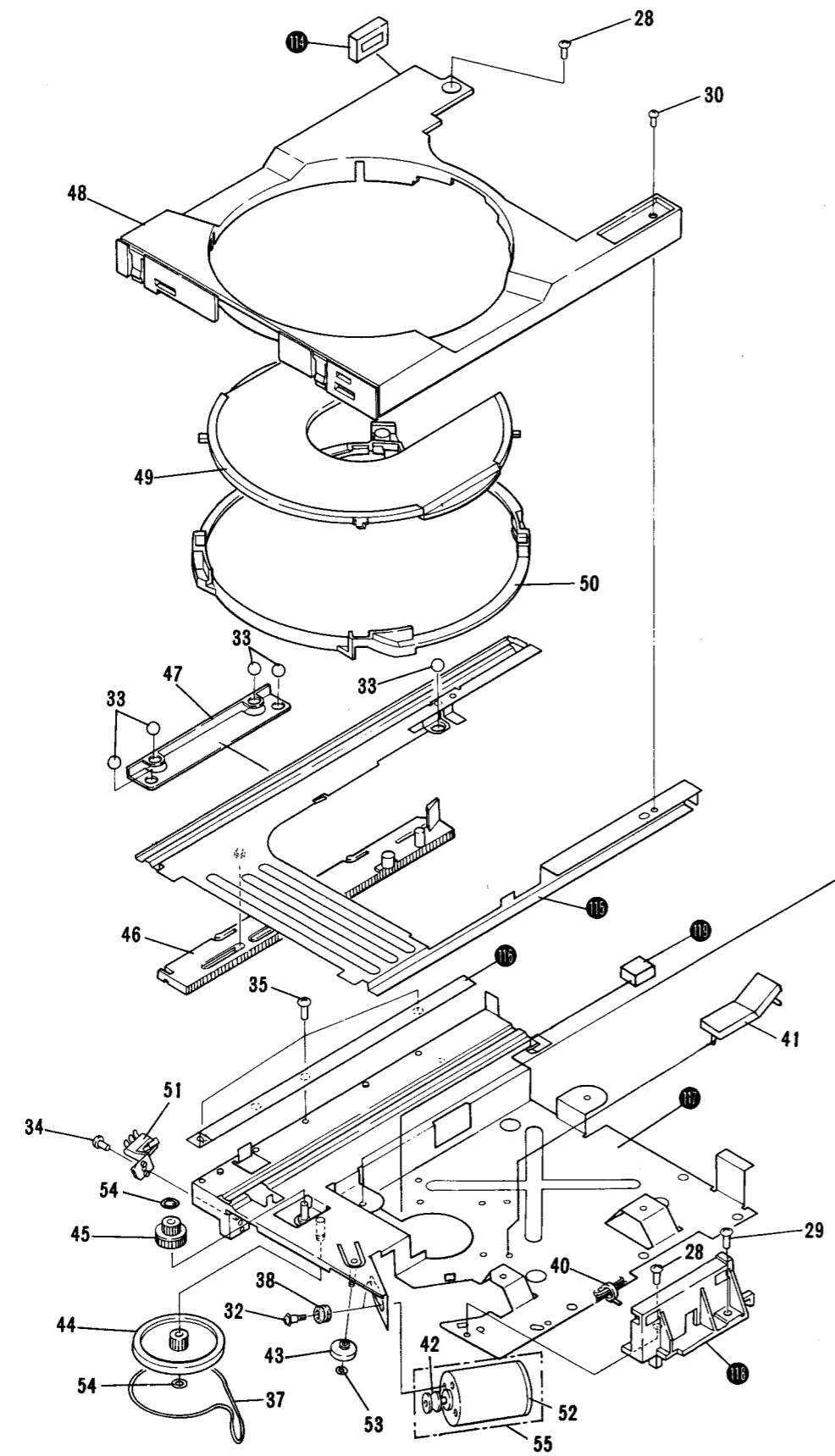

A

B

C

D

11

1

2

3

4

5

6

5. PACKING

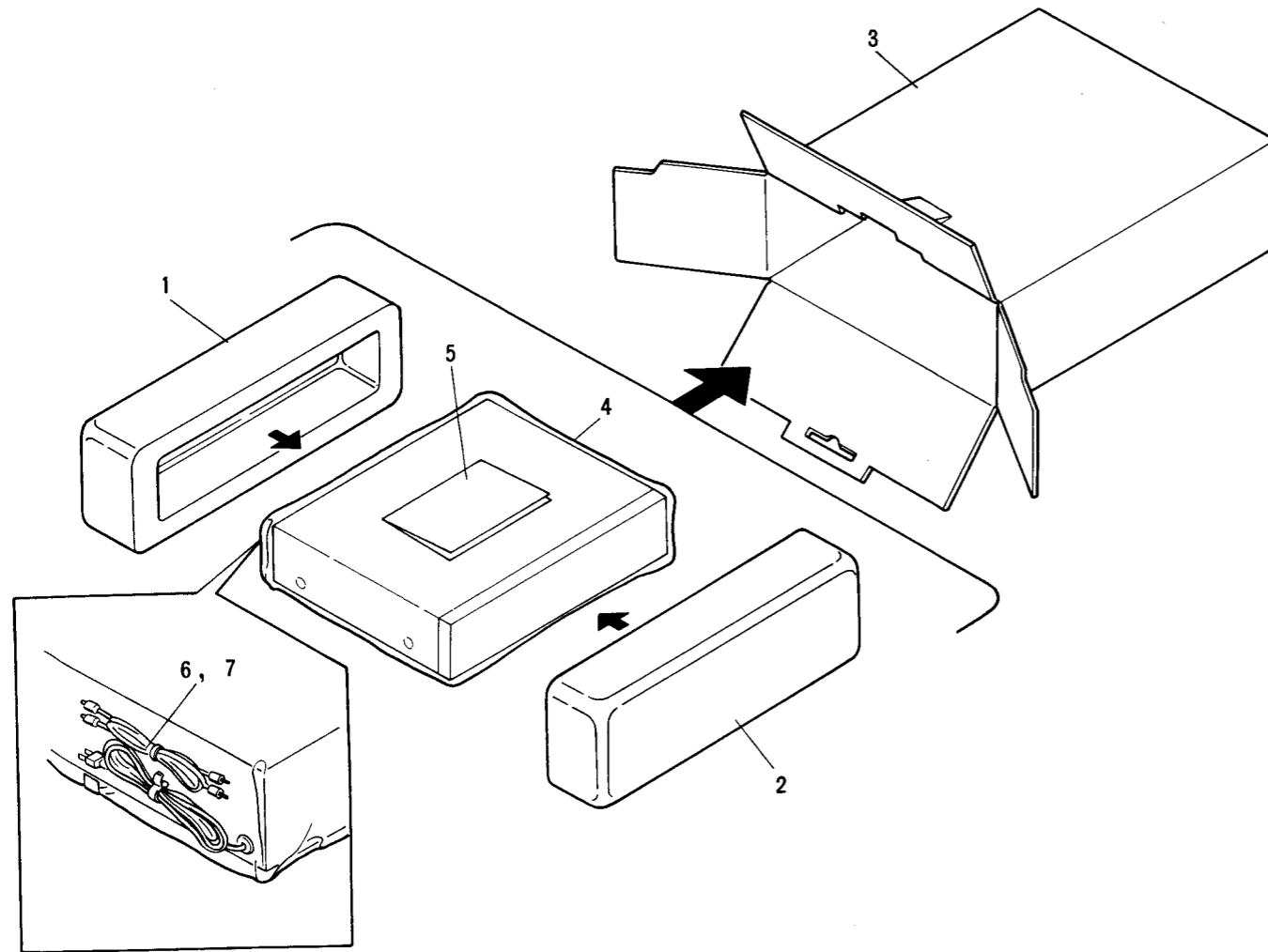

Parts List of Packing

Mark	No.	Part No.	Description
	1.	PHA1017	Protector (R)
	2.	PHA1016	Protector (F)
	3.	PHG1046	Packing case
	4.	Z23-007	Mirror mat sheet
	5.	PRE1012	Operating instructions
	6.	PDE1001	Connection cord with pin plug
	7.	PDE-319	Connection cord with mini plug

6. ELECTRICAL PARTS LIST

NOTES:

- When ordering resistors, first convert resistance values into code form as shown in the following examples.

Ex. 1 When there are 2 effective digits (any digit apart from 0), such as 560 ohm and 47k ohm (tolerance is shown by J = 5%, and K = 10%).

560Ω	56 × 10 ¹	561.....	RD1/4PS	5	5	J
47kΩ	47 × 10 ³	473.....	RD1/4PS	4	7	J
0.5Ω	0R5.....		RN2H	0	5	K
1Ω	010.....		RSIP	0	1	K

Ex. 2 When there are 3 effective digits (such as in high precision metal film resistors).

5.62kΩ	562 × 10 ¹	5621.....	RN1/4SR	5	6	2	F
--------	-----------------------	-----------	---------	---	---	---	---

- The Δ mark found on some component parts indicates the importance of the safety factor of the part. Therefore, when replacing, be sure to use parts of identical designation.
- For your parts Stock Control, the fast moving items are indicated with the marks $\star\star$ and \star .
- $\star\star$ GENERALLY MOVES FASTER THAN \star
- This classification shall be adjusted by each distributor because it depends on model number, temperature, humidity, etc.
- Parts marked by "●" are not always kept in stock. Their delivery time may be longer than usual or they may be unavailable.

Miscellaneous Parts

Mark	Symbol & Description	Part No.	Mark	Symbol & Description	Part No.
			$\star\star$	IC12	PD5037
Δ	Main board assembly	PWZ1086	Δ	IC3, IC7	TA7256P
Δ	Function board assembly	PWZ1089	$\star\star$	IC8, IC17, IC18	μ PC4072C
Δ	Transformer board assembly	PWZ1093	$\star\star$	Q33	DTC124ES
Δ	Primary board assembly	PWZ1096	$\star\star$	Q12, Q32	2SA1309A
	Pick up assembly	PWY-007	$\star\star$	Q17, Q18	2SD1302
			$\star\star$	Q13, Q14	2SK505
	$\star\star$ Slide switch (INSIDE, S101)	PSH-019			
	$\star\star$ Leaf switch (TRAY, S102)	PSN-006	\star	D7, D8, D25, D26	HZ6A1L (HZ6A2L)
	$\star\star$ Spindle motor	PXM-154			
	$\star\star$ Motor assembly (Carriage)	PYY-513	\star	D6	KV1225YBR (KV1226YBR)
	$\star\star$ Motor assembly (Loading)	PYY-514			
Δ	AC power cord	PDG1008	\star	D3	MTZ5.1B (MTZ5.1C) (RD5.1EB2) (RD5.1EB3)
Δ	\star Power transformer	PTT-270			
			\star	D13 - D20	S5566B
			\star	D41 - D43	1SS254

● Main Board Assembly (PWZ1086)

SEMICONDUCTORS

Mark	Symbol & Description	Part No.
$\star\star$	IC21	AN78L12
Δ	$\star\star$ IC23	AN78M05F
	$\star\star$ IC20	AN79L12
Δ	$\star\star$ IC22	AN79M05F
	$\star\star$ IC4	BA6109
	$\star\star$ IC10	CXK5816M-12L (CXK5816M-15L)
	$\star\star$ IC6	CX20108
	$\star\star$ IC5	CX20109
	$\star\star$ IC15	CX20152
	$\star\star$ IC9	CX23035
Δ	$\star\star$ IC30, IC31	ICP-F10
Δ	$\star\star$ IC1	IR3C01
Δ	$\star\star$ IC32	M51957AL
	$\star\star$ IC19	NJU4053B
	$\star\star$ IC11	PDE003

COILS AND FILTERS

Mark	Symbol & Description	Part No.
	L1 Radial inductor	LRA010K
	VL1 VCO coil	PTL-031
	F1, F2 Low pass filter	PTF1004

CAPACITORS

Mark	Symbol & Description	Part No.
	C83	CCCCH180J50
	C82, C84	CCCCH220J50
	C61, C62	CCCCH300J50
	C29, C53, C71	CCCCH330J50
	C72	CCCCH470J50
	C16, C47	CCCSL101J50
	C46, C66, C67	CCCSL221J50
	C25, C26	CCCSL470J50
	C31	CCCSL560J50
	C24	CCCSL680J50
	C21, C27	CCCSL820J50
	C52	CCCUJ221J50
	C50	CCCUJ331J50
	C48	CEANL010M50
	C44	CEANP010M50
	C49	CEANP100M25
	C34, C57, C170	CEANP2R2M50
	C86	CEASR33M50
	C22	CEASR47M50
	C114, C115	CKCYB102K50
	C11 - C13, C42, C74, C96, C111	CKCYF103Z50
	C99 - C102, C105 - C108, C116, C146	CKCYF473Z50
	C9, C10	CKCYX104M25
	C37, C81	CQMA102J50
	C28	CQMA103J50
	C55, C60	CQMA103K50
	C15, C39, C41, C56	CQMA104J50
	C45, C147, C148	CQMA222K50
	C30, C59	CQMA223J50
	C33	CQMA224K50
	C20, C144	CQMA333J50
	C40	CQMA682J50
	C35, C43	CQMA683J50
	C58	CQMA822J50
	C121, C122	CQSA102J50
	C125, C126	CQSA221J50
	C97, C98 (100μF/25V)	PCH1012
	C5, C6, C17, C19, C23, C32, C36	PCH1014
	C38, C63, C68, C70, C75, C76, C85, C87, C89, C92 (33μF/35V)	
	C4, C88, C90, C123, C124 (10μF/50V)	PCH1015
	C3, C117, C118 (22μF/50V)	PCH1016
	C129, C130 (1000μF/25V)	PCH1026
	C127, C128 (470μ/25V)	PCH1029
	C133, C134 (1000μF/16V)	PCH1036
	C136 (2200μF/16V)	PCH1037
	C135	CEAS332M16

RESISTORS

NOTE: When ordering resistors, convert the resistance value into code form, and then rewrite the part no. as before.

Mark	Symbol & Description	Part No.
★	VR6 Semi-fixed (47kΩ)	VRTB6VS473
★	VR5 Semi-fixed (100kΩ)	VRTB6VS104
★	VR3, VR4, VR7 Semi-fixed (10kΩ)	VRTB6VS103
	R81, R82, R84, R85	RN1/6P□□□□F
	R112 Resistor array	RA6S103J
	R113 Resistor array	RA7S103J
	R8, R9	RD1/2PM4R7J
	R1, R11, R13, R80, R90, R115, R116, R129, R130, R133 - R144, R147 - R150	RD1/4PM□□□J
	Other resistors	RD1/6PM□□□J

OTHERS

Mark	Symbol & Description	Part No.
	JA1 2P pin jack (CD OUT)	PKB-016
	JA3, JA4 3.5φ mini-jack	RKN-071
★	X2 Ceramic resonator	KBR-8.0M
★	X3 Ceramic resonator	KBR-800H
★	X4 Crystal resonator	PSS-008
★	X1 Crystal resonator	PSS-012

Function Board Assembly (PWZ1089)

SEMICONDUCTORS

Mark	Symbol & Description	Part No.
★ ★	IC201 Transistor array	IR2C30
★ ★	Q201 - Q206	2SA854S
★ ★	Q207	2SC3311A
★	D202 7seg. LED assembly	PCX1012
★	D204 LED	PY5724S-68
★	D203, D209 LED	SLH-56VC3
★	D205, D208	SLH-56YC3
★	D210, D212 - D215	1SS254

SWITCHES

Mark	Symbol & Description	Part No.
★ ★	S201 - S210 Tact switch (OPERATION, OPEN/CLOSE, REPEAT, PROGRAM MEMORY, ◀◀ • ▶▶ • ◀◀ • ▶▶)	PSG-065

CAPACITOR

Mark	Symbol & Description	Part No.
	C201	CEJA330M10

RESISTORS

NOTE: When ordering resistors, convert the resistance value into code form, and then rewrite the part no. as before.

Mark	Symbol & Description	Part No.
	All resistors	RD1/6PM□□□J

Transformer Board Assembly (PWZ1093)

Note: The power transformer (PTT-270) is not included with the transformer board assembly (PWZ 1093). If the power transformer is necessary, a separate order is required.

CAPACITORS

Mark	Symbol & Description	Part No.
	C140 - C143	CKDYF103Z50

Primary Board Assembly (PWZ1096)

SWITCH

Mark	Symbol & Description	Part No.
★ ★	S401 Power switch	PSA-009

CAPACITOR

Mark	Symbol & Description	Part No.
★	C401	RCG-009 (VCG-044)

7. P.C. BOARDS CONNECTION DIAGRAM

MAIN BOARD ASSEMBLY(PWZ1086)

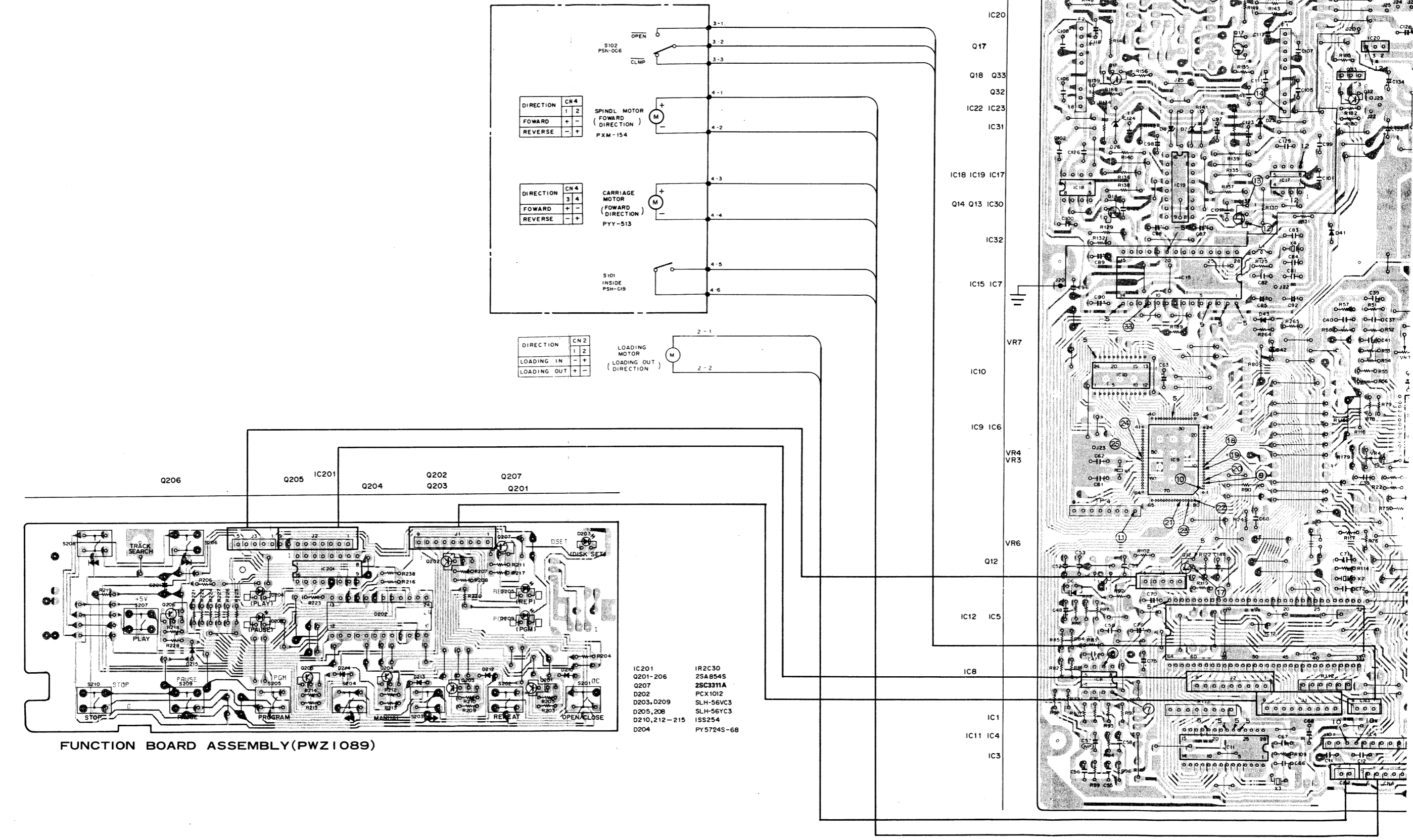

A
B
C
D

1 2 3 4 5 6

7

8

9

10

11

12

(PWZ1086)

PRIMARY BOARD ASSEMBLY (PWZ1096)

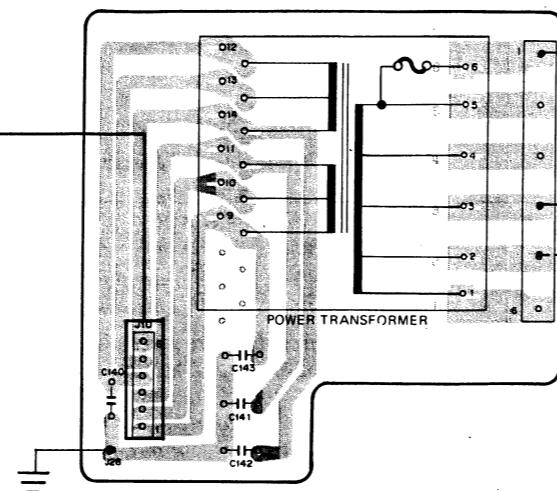
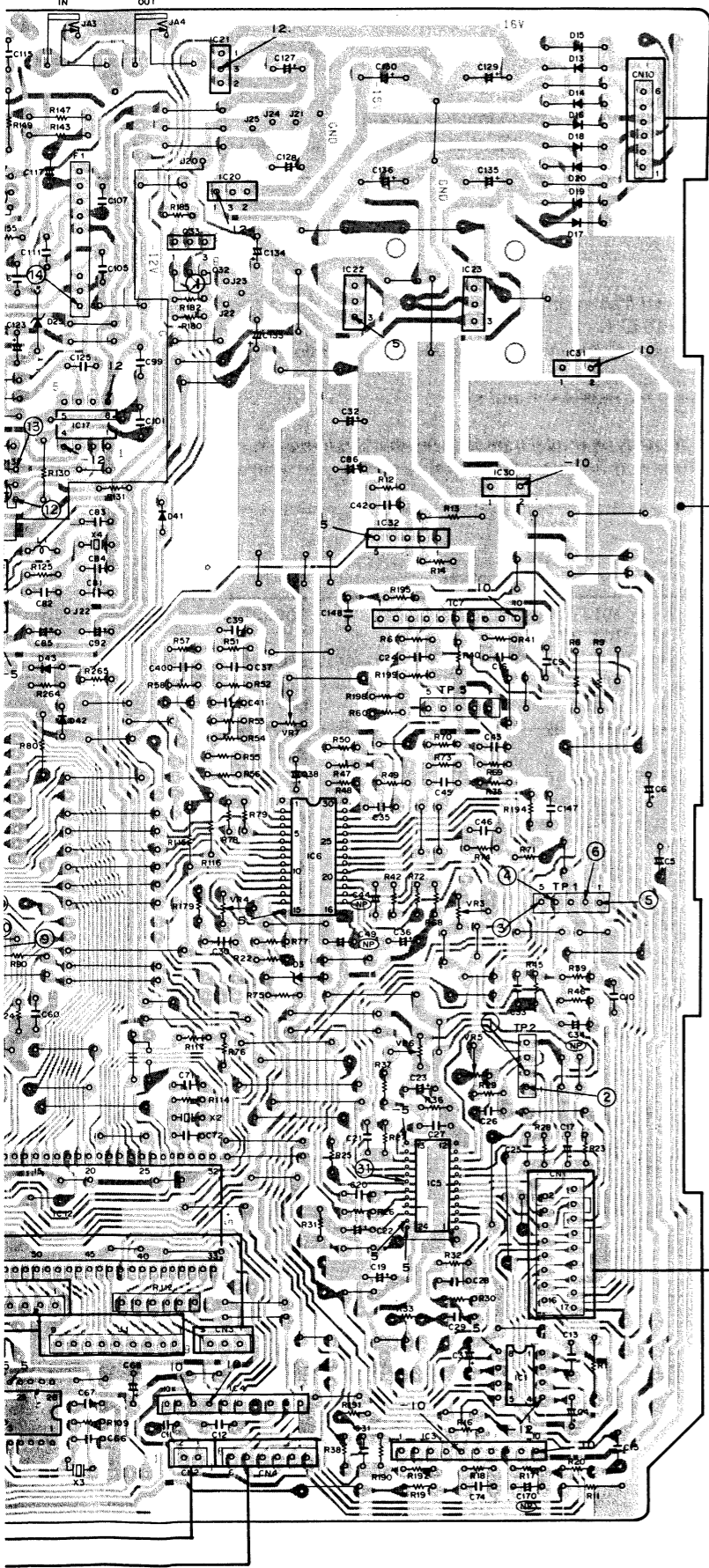

TRANSFORMER BOARD ASSEMBLY (PWZ1093)

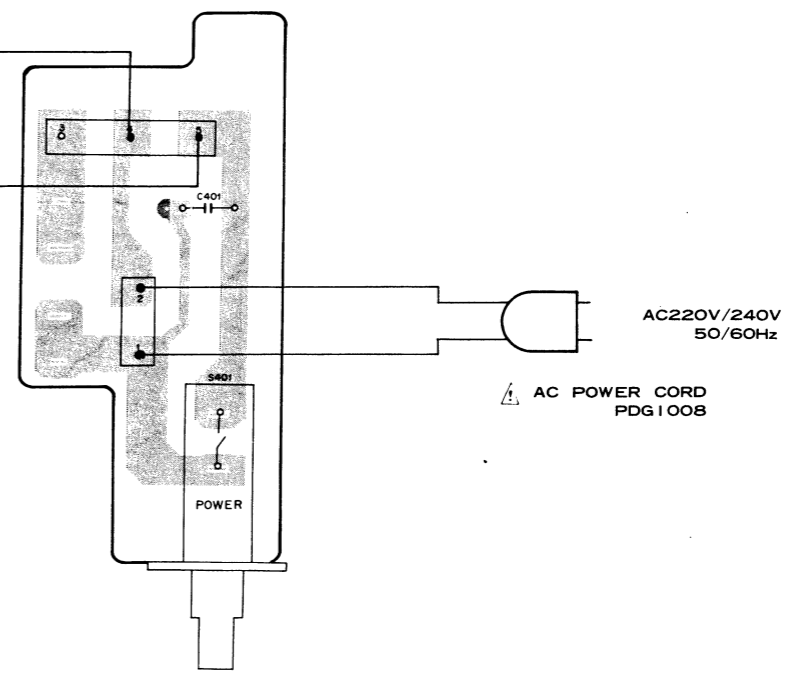

AC220V/240V 50/60Hz

AC POWER CORD PDG1008

POWER

- IC21 AN78L12
- IC23 AN78M05F
- IC20 AN79L12
- IC22 AN79M05F
- IC4 BA6109
- IC19 NJU4053B
- IC10 CXK5816M-12L (CXK5816M-15L)
- IC6 CX2010B
- IC5 CX20109
- IC15 CX20152
- IC9 CX23035
- IC30,31 ICP-F10
- IC1 IR3C01
- IC32 M51957AL
- IC8,17,18 PC4072C
- IC11 PDE003
- IC12 PD5037
- IC3,7 TA7256P
- Q33 DTC124ES
- Q12,32 2SA1309A
- Q17,18 2SD1302
- Q13,14 2SK505
- D7,8,25,26 H26A1L (H26A2L)
- D6 KV1225YBR (KV1226YBR)
- D3 MTZ5.1B (MTZ5.1C) (RD5.1EB2) (RD5.1EB3)
- D13-20 S5566B
- D41-43 1SS254

PICK UP ASSEMBLY (PWY-007)

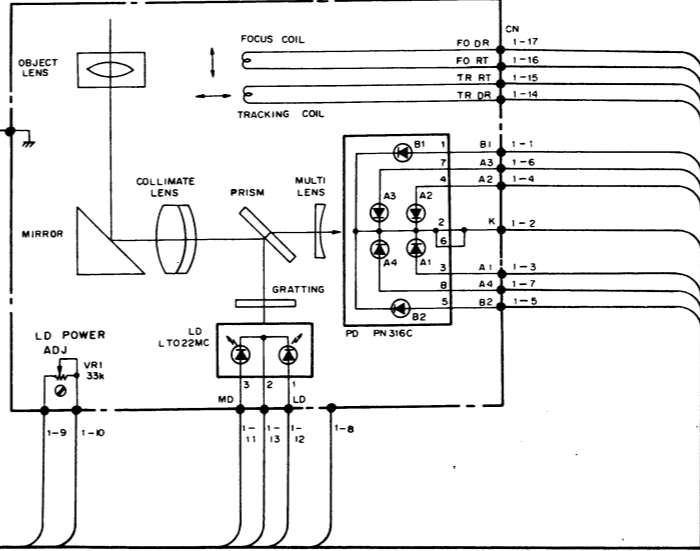

A

B

C

D

7

8

9

10

11

12

External Appearance of Transistors and ICs

2SA1309A
2SC3311A



2SD1302

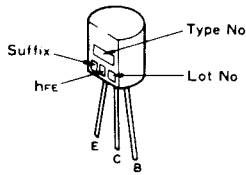

DTC124ES

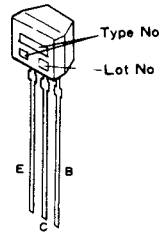

ICP-F10

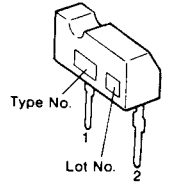

TA7256P

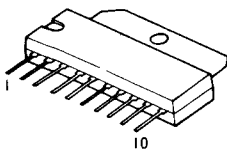

CX20108

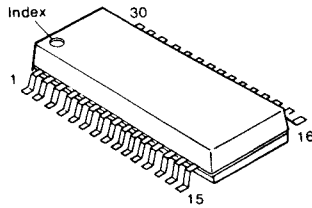

CX20152

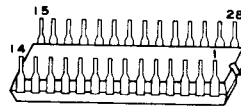

CX20109
CXK5816M-12L
CXK5816M-15L

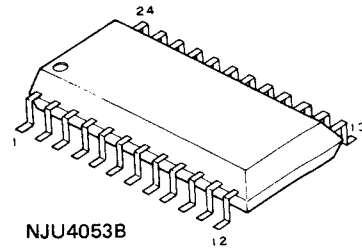

2SK505



BA6109

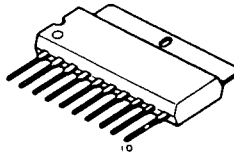

AN78M05F

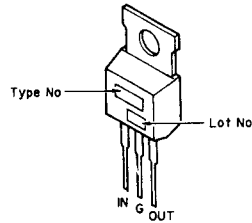

NJU4053B
IR2C30

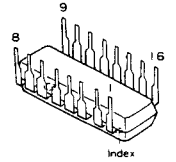

AN78L12

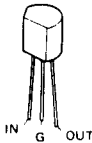

AN79L12
AN79M05F

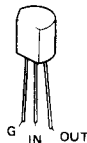

2SA854S

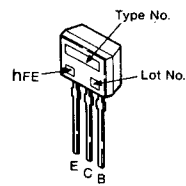

M51957AL

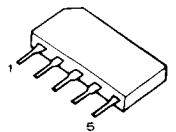

IR3C01
 μ PC4072C

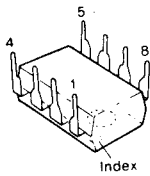

PDE003

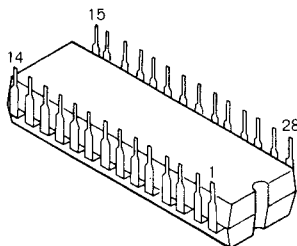

PD5037

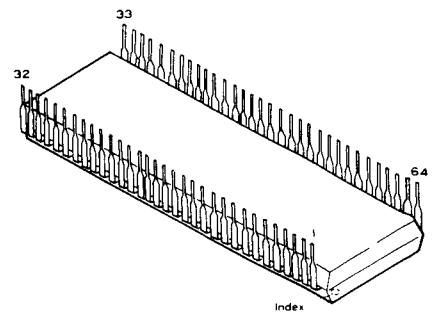

CX23035

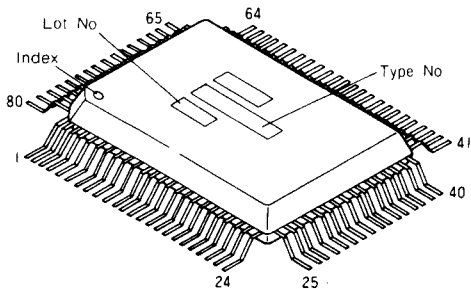

● List of Symbols

Symbol	Signal Source	Signal Name	Function
B1			Tracking signal lead code detector
A0~A10	IC9-38~48	Address line	
A1 ~ A4			Output from 1/4 divider detectors used to detect RF and focus signals
BCLK	IC9-76	Bit clock	
B2			Pulse signal for track count
C-OUT	IC6-6	Counter out	Noise-processed tracking error signal
C1F1	IC9-62	Error flag	Flags indicating when decoder LSI is correcting errors
C1F2	IC9-63	Error flag	
C2F1	IC9-64	Error flag	
C2F2	IC9-65	Error flag	
CA·DR	IC3-2	Carriage drive	Carriage motor drive output
CLK	IC12-19	Clock	IC6 and IC9 control data (serial) clock (Undriven)
CLMP	S102	Clamp	Disc tray status (L: closed, H: open or moving)
CRCF	IC9-20		Sub-code Q error detection result output (synchronized with SCOR signal)
CS	IC9-50	Chip select	RAM activator control signal
D1~D8	IC9-37~34 32~29	Data line	RAM data line
DATA	IC9-78	Data	DAC playback signal data (serial)
DEMP	IC12-8	De-emphasis	De-emphasis on/off signal (L: de-emphasis ON)
DIRC	IC12-22	Direct	Control signal involved in single track jumping (control only while signal is at L level)
EXCK	IC9-21	External clock	External clock input
FO·DR	IC7-8	Focus drive	Focus actuator drive signal
FO·ER	IC5-16	Focus error	Focus error signal
FO·IN	TP5-1	Focus loop in	Focus servo gain adjustment input
FO·OT	TP5-2	Focus loop out	Focus servo gain adjustment output
FO·RT	TP1-1	Focus return	Focus actuator drive current detector
FOK	IC5-1	Focus OK	H level output to indicate that "in focus" status is set when RF signal is obtained
GFS	IC9-28	GFS	Frame sync lock status output (H: locked)
GND		GND	
INS \bar{D}	S101	Inside	Detector signal indicating that pick-up has reached inside track
K			
L·IN	IC12-42	Loading in	Loading-in control signal
L·OUT	IC12-41	Loading out	Loading-out control signal
LD ON	IC12-24	Laser diode on	Laser diode switching signal (H: diode ON)
LOAD +	IC4-2		Loading motor drive voltage output
LOAD -	IC4-10		
LRCK	IC9-80	LR clock	Clock for switching decoder (DAC) left/right channels

Symbol	Signal Source	Signal Name	Function
MIRR	IC5-18	Mirror	Pitless side (mirror surface) detector signal (pitless side:H)
MRIH	IC12-9	Mirror inhibit	Control signal which prevents MIRR signal to go from IC5 to IC9. (unused)
MUTE	IC12-14	Muting	IC9 digital mute control signal
OPEN	S102	Open	Output from switch which detects when disc tray is open (open: L)
RAOV	IC9-57	RAM overflow	Output signal generated when RAM area overflow occurs (overflow: H)
$\overline{\text{RESET}}$	IC32-5	Reset	Power ON reset signal
RFCK	TP4-7 (IC9-26)	Read frame clock	Standard frame clock signal (7.35kHz)
SCOR	IC9-24		Sub-code sync
SENS	IC6-5		Detector output bus from IC6 & IC9
SP·DR	CN4-1	Spindle drive	Spindle motor drive output
SP·RT	CN4-2	Spindle return	Spindle motor drive current detector
SUBQ	IC9-23	Sub-code Q	Sub-code Q output (address and other data)
TR·DR	IC7-2	Tracking drive	Tracking actuator drive signal
TR·ER	IC5-17	Tracking error	Tracking servo error output
TR·IN	TP5-5	Tracking loop in	Tracking servo gain adjustment input
TR·OT	TP5-4	Tracking loop out	Tracking servo gain adjustment output
TR·RT	TP1-2	Tracking return	Tracking actuator drive current detector
WDCK	IC9-79		Digital filter 88.2kHz strobe signal output
$\overline{\text{WE}}$	IC9-49	Write enable	RAM write enable
WFCK	IC9-25	Write from clock	Frame clock signal made from data (frame sync. lock: 7.35kHz)
$\overline{\text{XLT}}$	IC12-12		Servo and decode IC serial data latch clock pulase signal

	PLAY	SEARCH
①		
②		
③		
④		
⑤		
⑥		
⑦		
⑧		
⑨		

	PLAY	SEARCH
⑩		
⑪		
⑫		
⑬		
⑭		
⑮		

	POWER ON	POWER OFF
⑯		

8. SCHEMATIC DIAGRAM

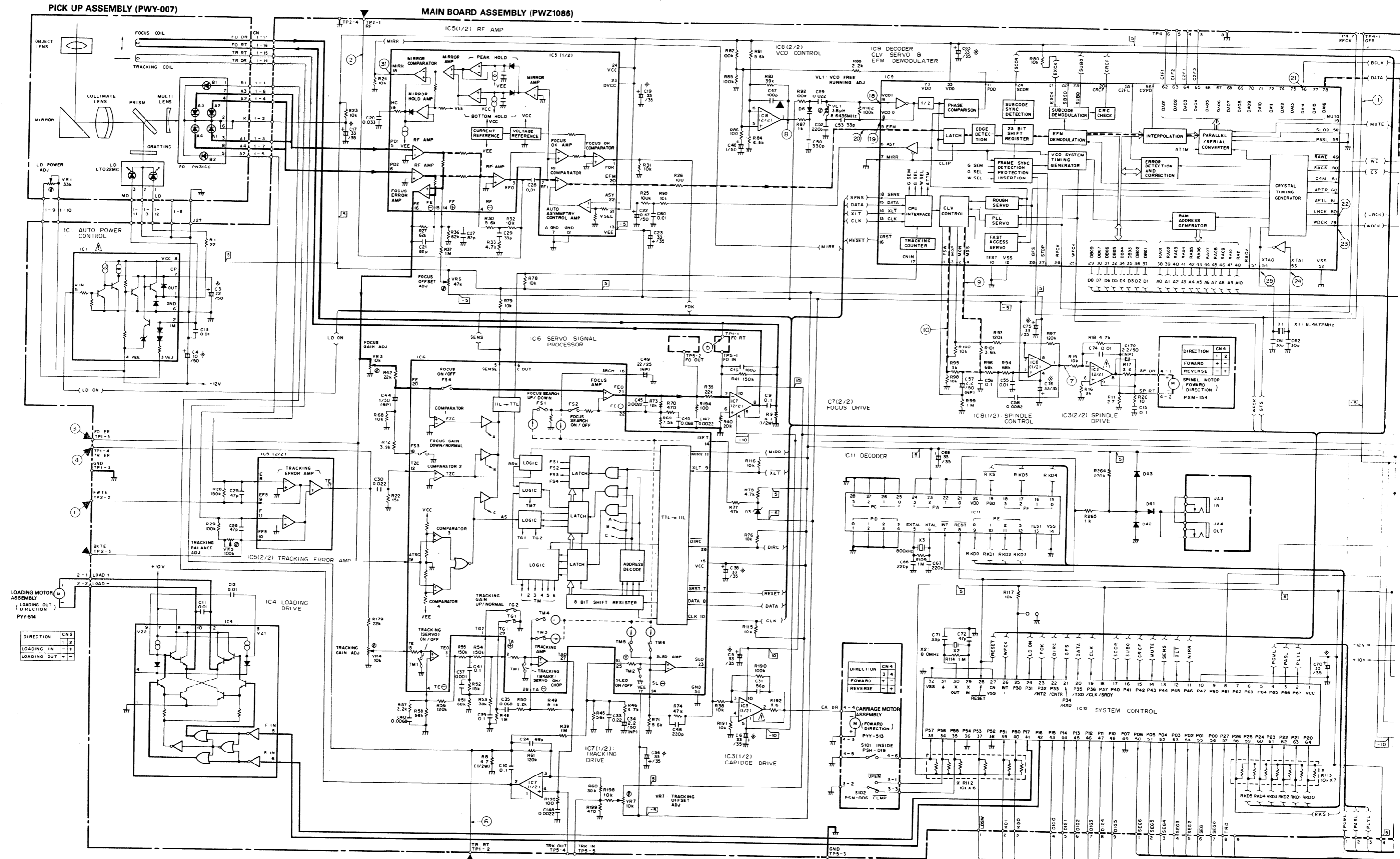

A

B

C

D

1

2

3

4

5

6

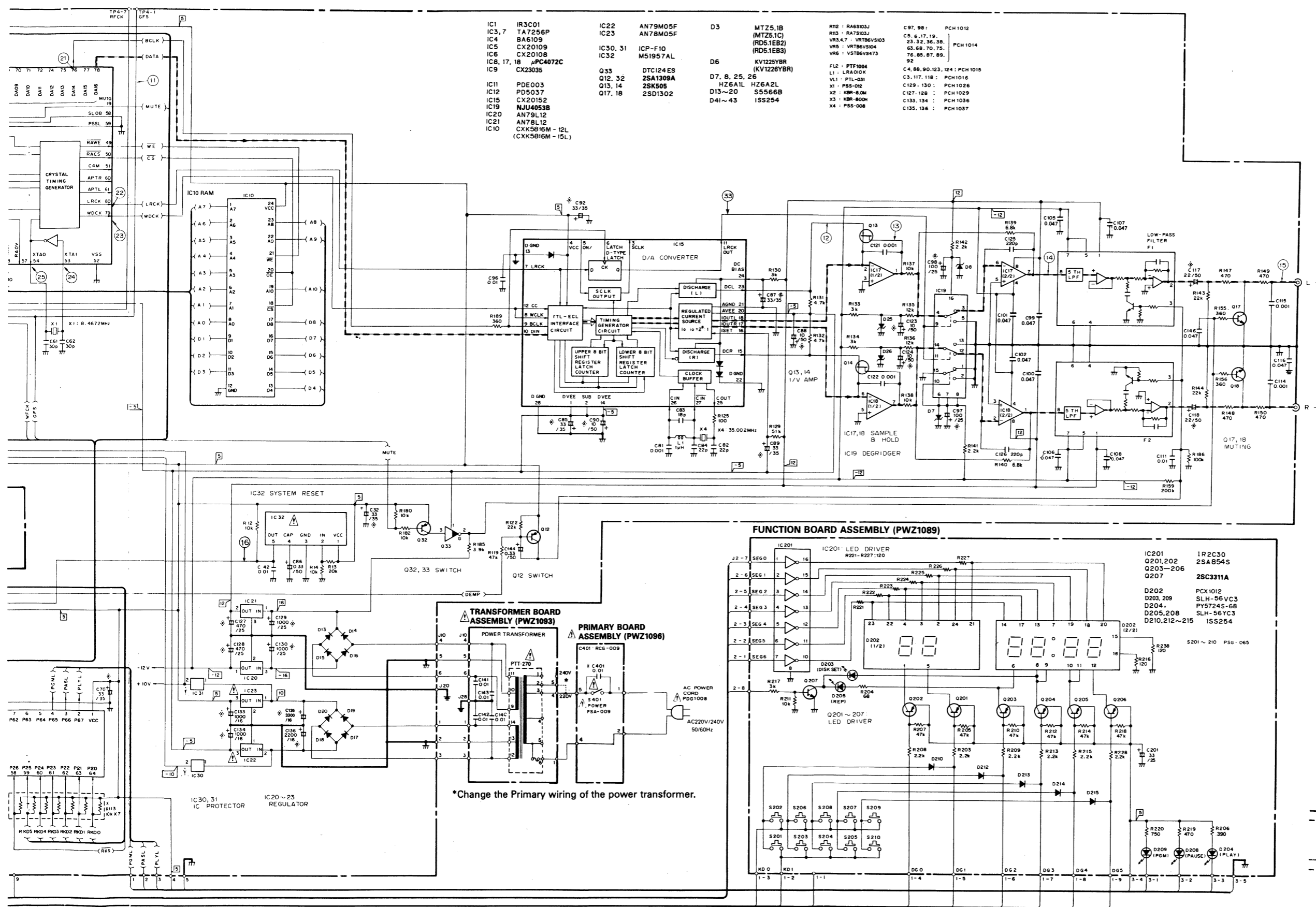

- RESISTORS:** Indicated in Ω, kΩ, MΩ, 1/2W, 1/4W, 5% tolerance unless otherwise noted; k, 1%, M, 1%, (F), 1%, (G), 2%, (K), 10%, (M), 20% tolerance.
- CAPACITORS:** Indicated in capacity (μF)/voltage (V) unless otherwise noted; p, pF. Indication without voltage is 50V except electrolytic capacitor.
- VOLTAGE CURRENT:** DC voltage (V) at no input signal. Value in () is DC voltage at rated power.
- OTHERS:**
 - ⊕: Chassis GND
 - : Signal route
 - ↔: Adjusting point
 - ⊗: The mark found on some component parts indicates the importance of the safety factor of the part. Therefore, when replacing, be sure to use parts of identical designation.
 - ⊛: marked capacitors and resistors have parts numbers

This is the basic schematic diagram, but the actual circuit may vary due to improvements in design.

The waveforms at each measuring point indicated by the encircled numbers are given on pages 29 thru 32.

- SWITCHES:**
- FUNCTION BOARD ASSEMBLY**
- S201: OPEN/CLOSE
 - S202: REPEAT
 - S203: (MANUAL SEARCH)
 - S204: (MANUAL SEARCH)
 - S205: PROGRAM MEMORY
 - S207: PLAY
 - S209: PAUSE
 - S206: (TRACK SEARCH)
 - S208: (TRACK SEARCH)
 - S210: STOP/CLEAR
- PRIMARY BOARD ASSEMBLY**
- S401: POWER ON-OFF
- OUTSIDE OF P.C. BOARD ASSEMBLY**
- S101: INSIDE
 - S102: CLAMP
 - CLAMP: OPEN

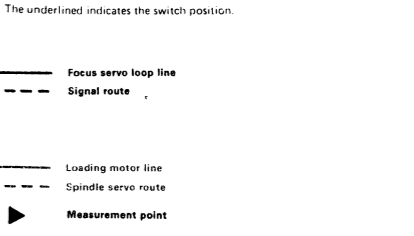

A

B

C

D

● Wave Form

NOTE: The encircled numbers denote measuring points in the circuit and pattern diagrams.

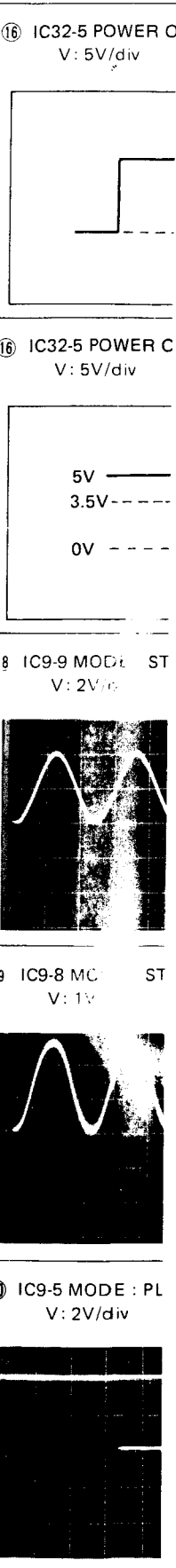
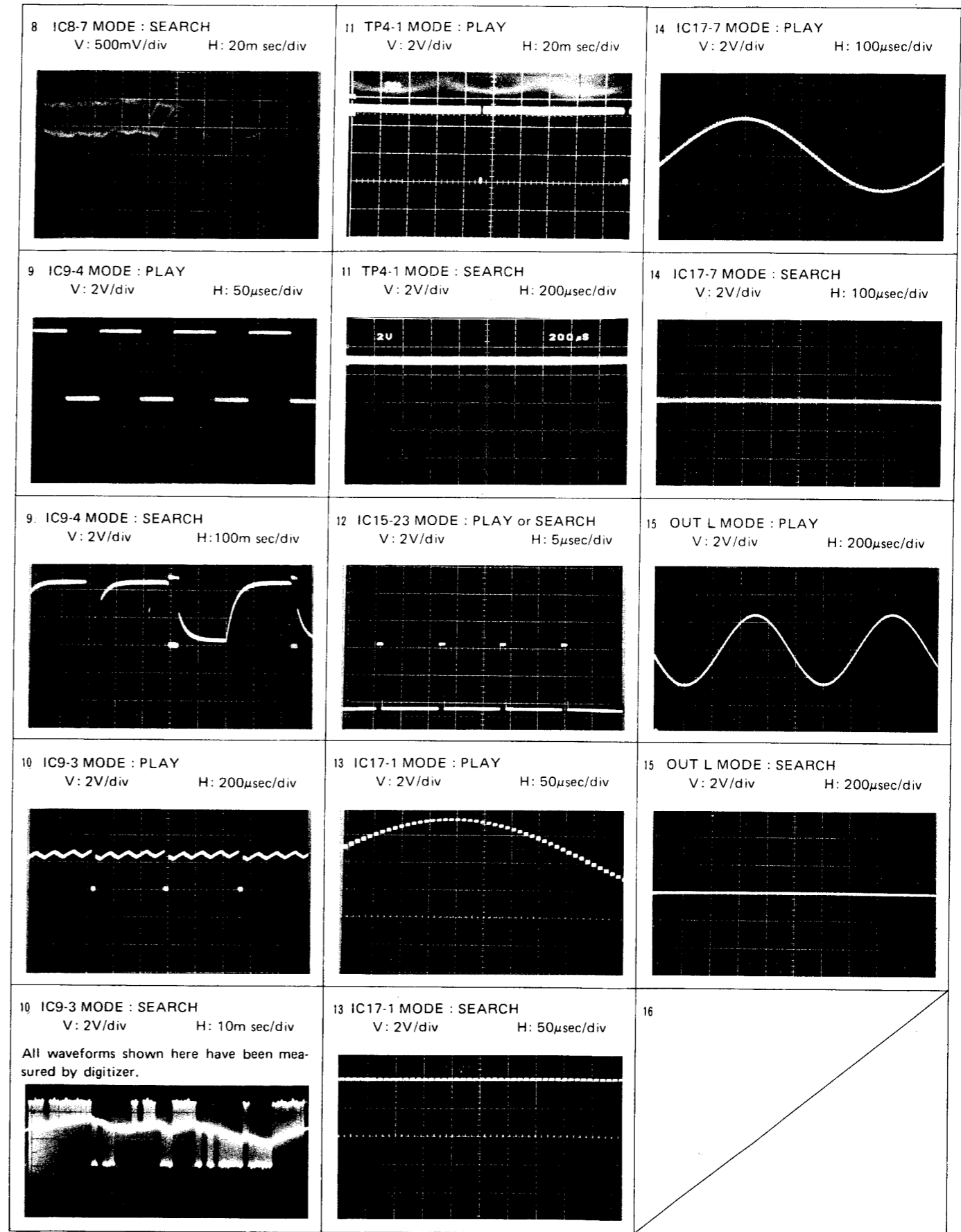
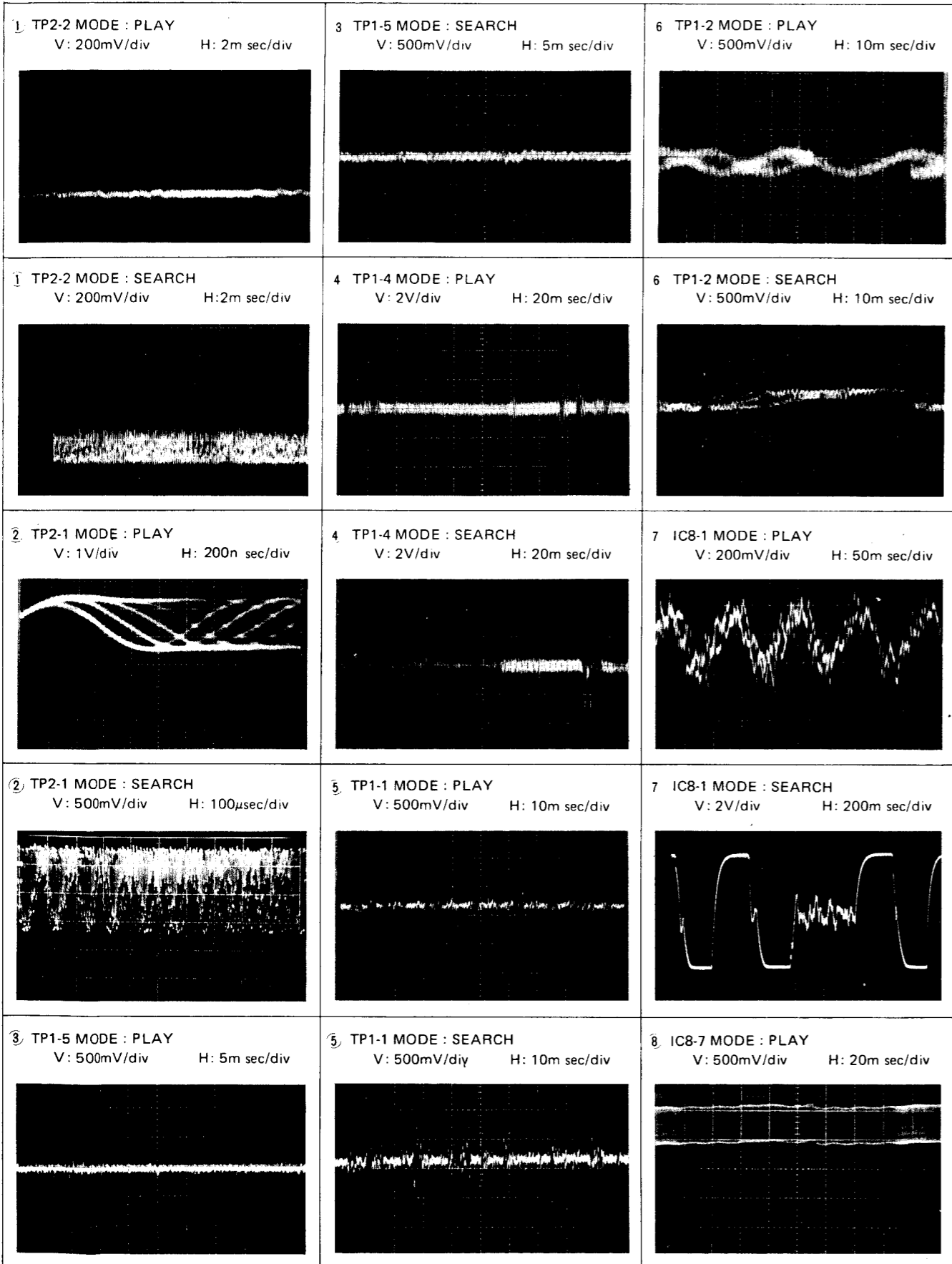

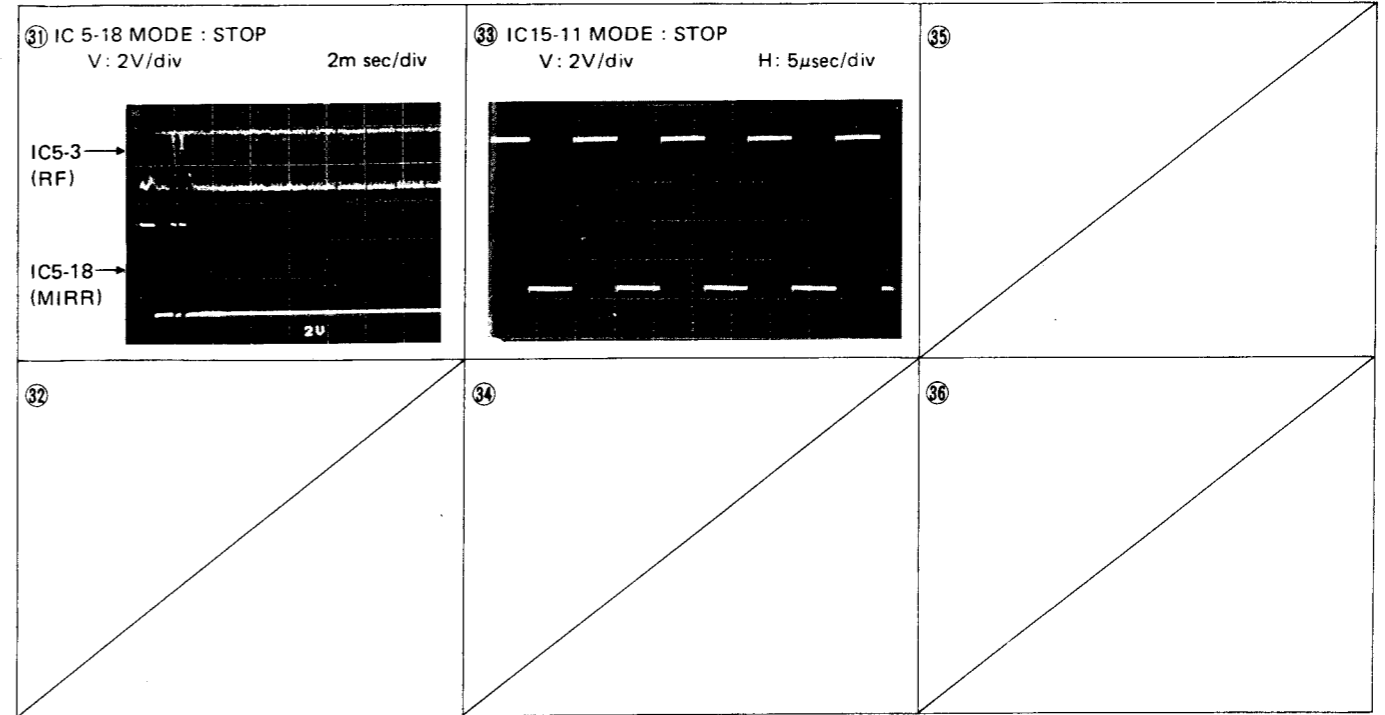
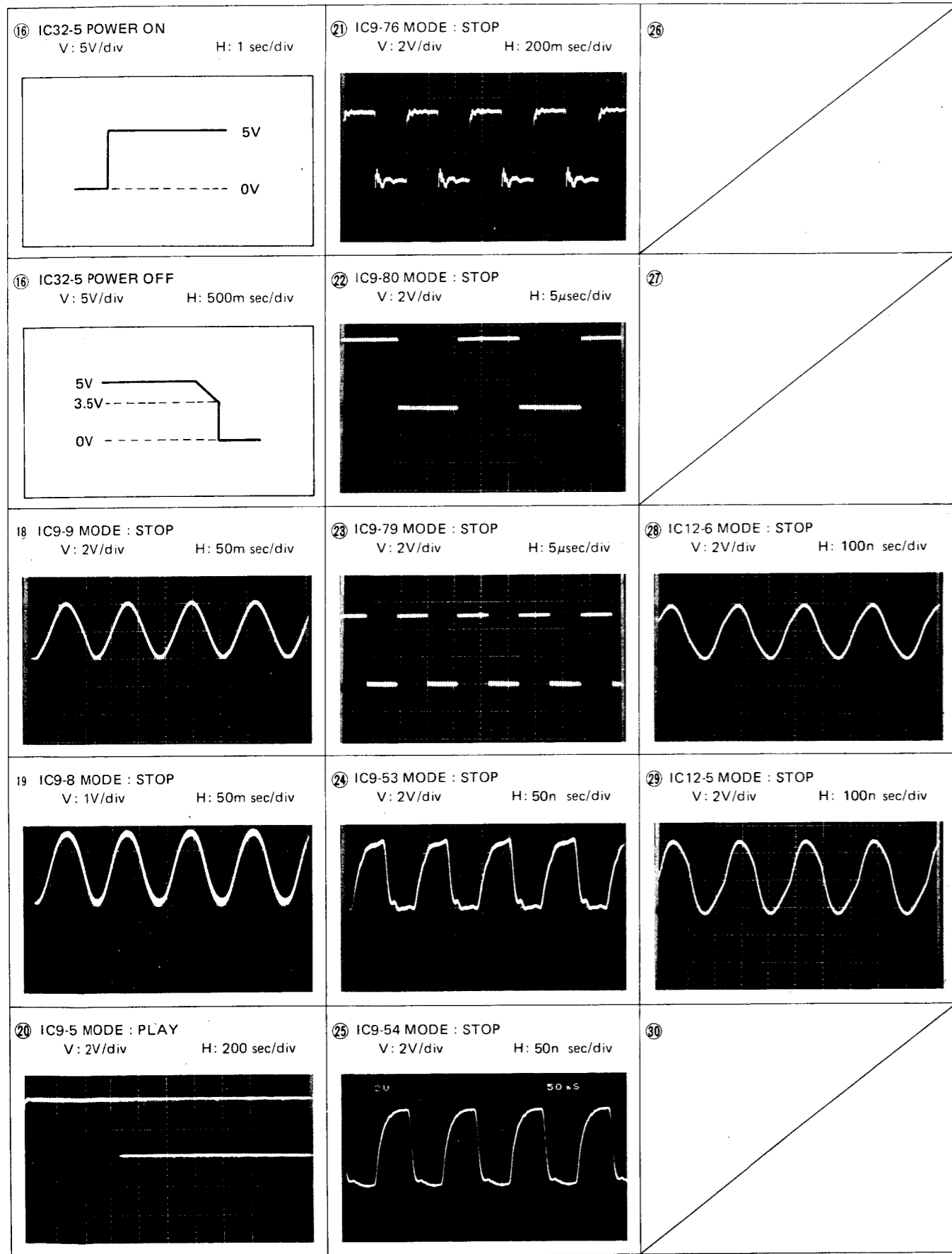

9. ADJUSTMENTS

The Compact Disc Player adjustment are to be executed in the following order.

● Adjustment Items

1. Tracking offset and focus offset adjustments
2. LD (laser diode) power check
3. Focus lock and spindle lock checks
4. Grating adjustment
5. Tracking balance adjustment
6. Tangential adjustment
7. Focus gain adjustment
8. Tracking gain adjustment
9. VCO free-run frequency adjustment

● Measuring Equipment

1. Dual trace oscilloscope
2. Optical power meter
3. Test disc (YEDS7)
4. Focus and tracking adjustment filters
5. Loop gain adjustment bandpass filter
6. Signal generator
7. Grating driver
8. Other regular measuring equipment

● Test Mode

Disc player adjustments are executed in test mode.

— Test mode setting and cancellation procedures —

- (1) After shorting the test mode jumper wires with a pair of tweezers or similar instrument, turn on POWER SW (S401).
- (2) Then switch the MANUAL SEARCH FWD (\triangleright) or REV (\triangleleft) switch on to activate test mode.
- (3) Test mode is cancelled by switching POWER off.

The various key functions during test mode are listed in Table 9-1.

● Adjustment Controls

- VR7: Tracking offset (TR.OF)
- VR3: Focus gain (FO.GA)
- VR4: Tracking gain (TR.GA)
- VR5: Tracking balance (TR.BL.)
- VR6: Focus offset (FO.OF)
- VL1: VCO frequency

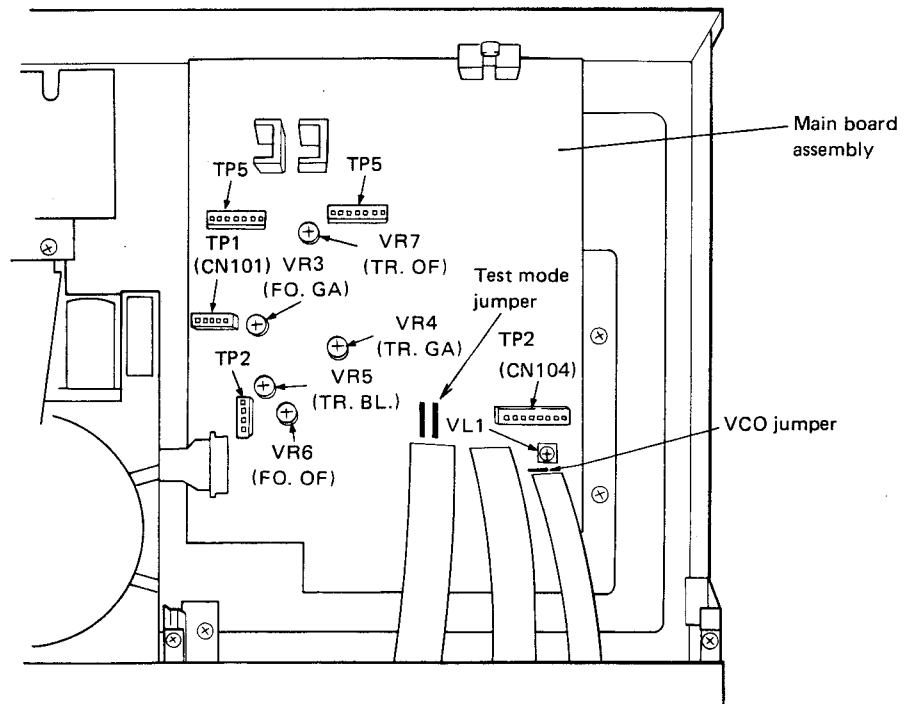

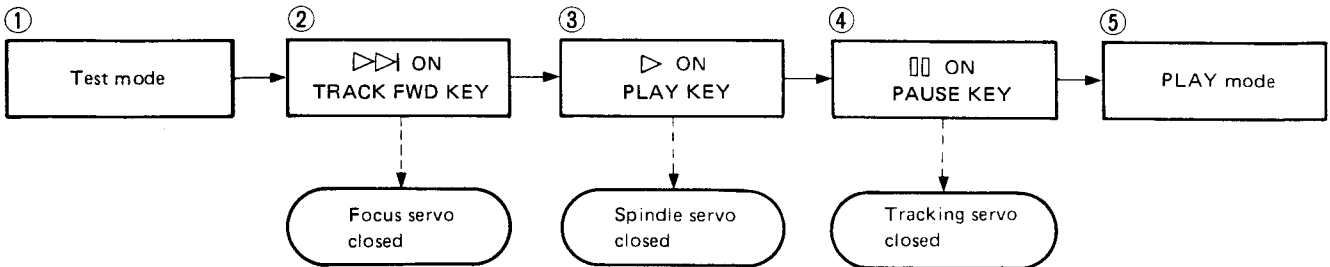

Fig. 9-1 Adjustment Points

During test mode, each servo mechanism can be closed and opened by separate operations. Consequently, each servo must be closed one at a time

(in serial sequence) to set play mode. Note that play mode is not activated by simply pressing the PAUSE key () during test mode.









Example: Switch from stop to play mode.



- Each servo of the test mode is in serial sequence.

• Key Function in Test Mode

Table 9-1 Key function

Symbol	Key	Function during test mode	Description
	TRACK BACK	Laser diode on	Laser diode lights up
	TRACK FWD	Focus servo closed	Laser diode lights up, focus actuator is moved up/down, and focus servo is closed.
	PLAY	Spindle servo closed	Spindle servo closed in CLV-A mode after spindle motor is kicked.
	PAUSE	Tracking servo closed/opened	Tracking servo closed by pressing in a toggle action, and player is switched to play mode (with the focus and spindle servos closed). PAUSE indicator lights up, and tracking servo is opened when pressed a second time.
	MANUAL SEARCH REV	Carriage reverse (towards disc center)	Carriage is moved towards disc center at the fast speed of about 1cm/sec. Since there is no safety mechanism to stop the carriage, do not move it too far.
	MANUAL SEARCH FWD	Carriage forward (towards disc edge)	Carriage is moved towards disc edge at the fast speed of about 1cm/sec. Since there is no safety mechanism to stop the carriage, do not move it too far.
	REPEAT	Lens moved up/down	The laser diode lights up, and the focus actuator is moved up/down. The focus servo is not closed.
	STOP	Stop	All servos are stopped and reset to the initial status.
	OPEN/CLOSE	(Disc tray) opened/closed	Disc tray is opened/closed. Note pickup does not return to arm rest when tray is opened, and remains in the same position when tray is closed.

Step No.	Oscilloscope position		Test points	Adjustment positions	Check items/ Adjustment specifications	Adjustment procedure
	V	H				
1 TRACKING OFFSET AND FOCUS OFFSET ADJUSTMENT						
			TP 1 Pin 2 (TR. RT)	VR 7 (TR. OF)	0V ± 10mV	<ul style="list-style-type: none"> Set the player to test mode (see page 33). Adjust the voltage at TP1 pin 2 TR.RT (tracking return) to 0V ±10mV by turning the VR 7 TR.OF (tracking offset) control.
			TP 1 Pin 5 (FO. ER)	VR 6 (FO.OF)	0V ± 10mV	<ul style="list-style-type: none"> Adjust the voltage at TP1 pin 5 FO.ER (focus error) to 0V ±10mV by turning the VR6 FO.OF (focus offset) control. <p><i>Note: When adjusting VR7, be careful not to short VR7 and the IC7 heat sink (wrap insulating material around the screw driver as a precaution).</i></p>
2 LD (LASER DIODE) POWER CHECK						
				VR1	Specified rating (0.21mW ± 0.02mW)	<ul style="list-style-type: none"> Set to test mode. (See page 33) Press the TRACK BACK key, and turn on the LD (laser diode). Place the optical power meter's sensor directly above the objective lens, and check if LD power is of standard value (0.21 mW ±0.02 mW). If LD power is not a standard value, adjust it with the LD power adjustment volume (within the pickup Ass'y). After adjusting the LD power, play a test disc (YEDS7), and measure the p-p voltage of the RF waveform. If the p-p voltage of the RF waveform exceeds 1.5 V, adjust the LD power so that the p-p voltage will be about 1.5 V.
3 FOCUS LOCK AND SPINDLE LOCK ADJUSTMENT						
	V 0.5V/div	H 100msec /div	TP2 Pin 1 (RF output)		RF output generated Normal rotation	<ul style="list-style-type: none"> Load the test disc. Set the player to test mode (see page 33). Press the MANUAL SEARCH FWD key (▷▷) to move the pick-up to about the center of the disc. Note that step must be executed. Observe TP2 pin 1 RF (RF output) by oscilloscope to check that an RF output signal is generated when the TRACK FWD key (▷▷) is pressed. Press the PLAY key (▷) and check that the disc rotates at normal speed (about 300rpm near the center of the disc) in the correct direction (clockwise).

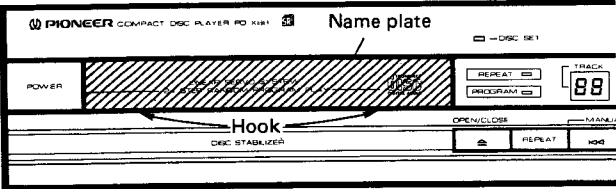
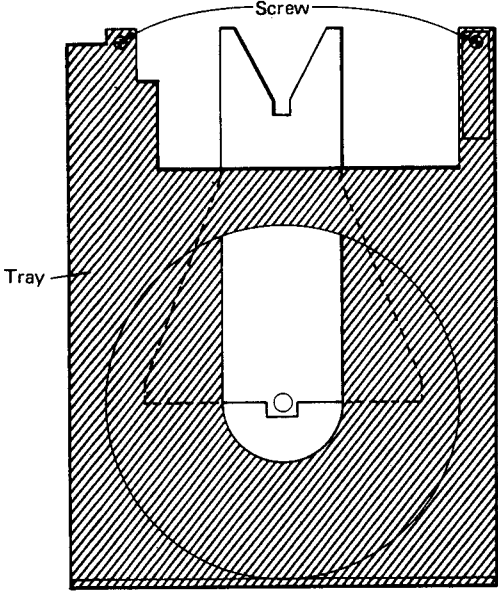
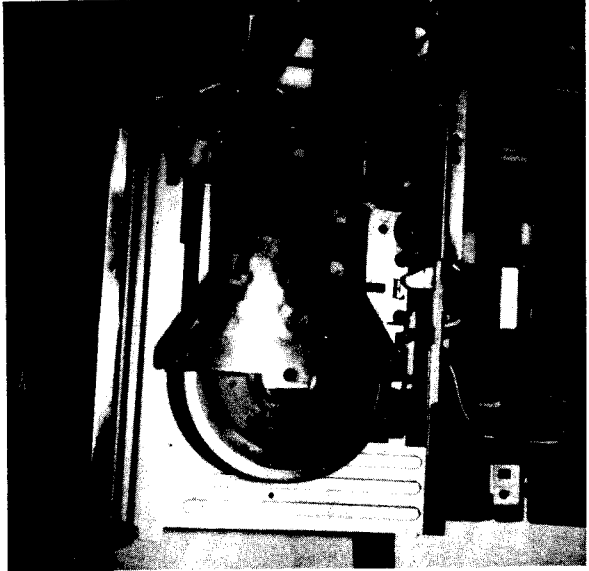
Step No.	Oscilloscope Setting		Test Points	Adjusting Points	Check items/ Adjustment specifications	Adjustment procedure
	V	H				
						<ul style="list-style-type: none"> • Perform this adjustment after removing the disc tray. • Disc Tray Removal <ol style="list-style-type: none"> 1. Turn on the power, and pull out the disc tray. 2. Remove the two lower stoppers and pull up the name plate to remove. (Fig. 9-2) 3. Remove the front panel. 4. Remove the two screws which secure the tray and the slide base unit. (Fig. 9-3) 5. Pull out the tray, plate, and belt cam along the slide rail unit. (Fig. 9-3) <ul style="list-style-type: none"> • Photograph 9-1 shows the unit after the disc tray is removed through steps 1 to 5. • Grating adjustment can now be done.
						 <p>Remove the name plate.</p> <p>Fig. 9-2</p>  <p>Remove the two screws securing the disc tray, and pull out the disc tray.</p> <p>Fig. 9-3</p>  <p>Photograph 9-1 With the disc tray removed.</p>

Step No.	Oscilloscope position		Test points	Adjustment positions	Check items/ Adjustment specifications	Adjustment procedure
	V	H				
						<ul style="list-style-type: none"> • Raise the clumper, and insert the test disc. • Set the player to test mode (see page 33). • Press the TRACK FWD ($\triangleright\triangleright$) and PLAY (\triangleright) keys in that order to close the focus and spindle servos (leaving the tracking servo open). • Using the MANUAL SEARCH FWD key ($\triangleright\triangleright$), move the pick-up to a position near the outside of the disc, and ensure that the \ominus driver can enter the pick-up grating adjustment hole from the top of the set by the pick-up movement. (See Fig. 9-4).
						<ul style="list-style-type: none"> • Observe the TP1 pin 4 TR.ER (tracking error) waveform by oscilloscope. Insert a 4kHz cut-off low pass filter at this stage. (See Fig. 9-5)
	1V/div.	5ms/div.	TP 1 Pin 4 (TR. ER)	Grating	NULL point	<ul style="list-style-type: none"> • Insert the tracking driver into the adjustment hole and turn the driver to find the NULL point (see Photograph 9-2). • Next turn the grating driver slowly clockwise from the NULL point and adjust to the position where the waveform (tracking error signal) first reaches maximum amplitude (see photograph 9-4). NOTE: Push down the grating driver so that the pickup unit does not rise.
						<ul style="list-style-type: none"> • Connect TP2 pin 3 (BKTE) to the X axis of the oscilloscope, and pin 2 (FWTE) to the Y axis by AC coupling, and observe the Lissajous pattern (see Photograph 9-5). • Fine adjust the grating driver to a position where the Lissajous pattern in practically as straight line (Lissajous 180°). (See Photograph 9-6)
			X axis TP2 pin 3 (BKTE)	Grating	Lissajous 180°	
			Y axis TP2 pin 2 (FWTE)	Grating	Maximum amplitude	

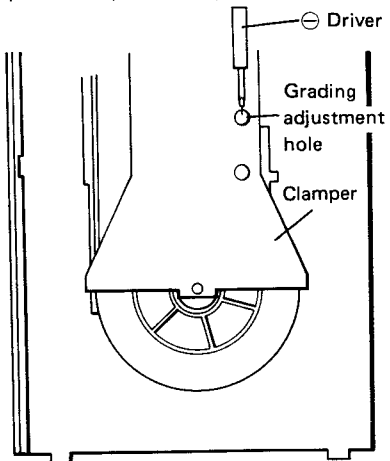

Fig. 9-4 Adjustment point

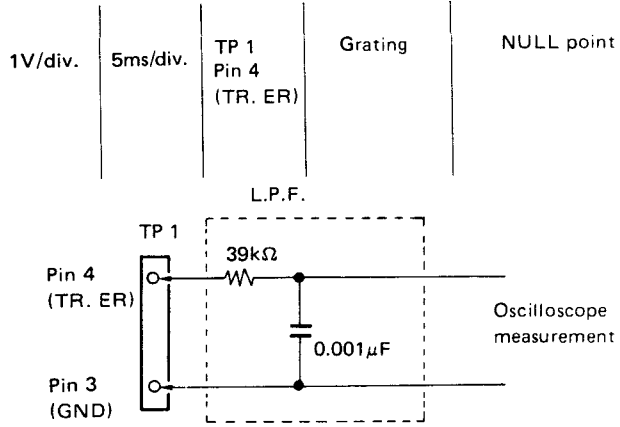

Fig. 9-5 L.P.F.

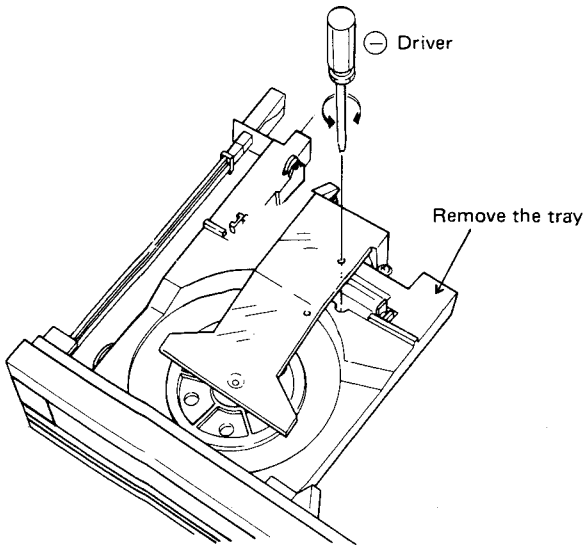
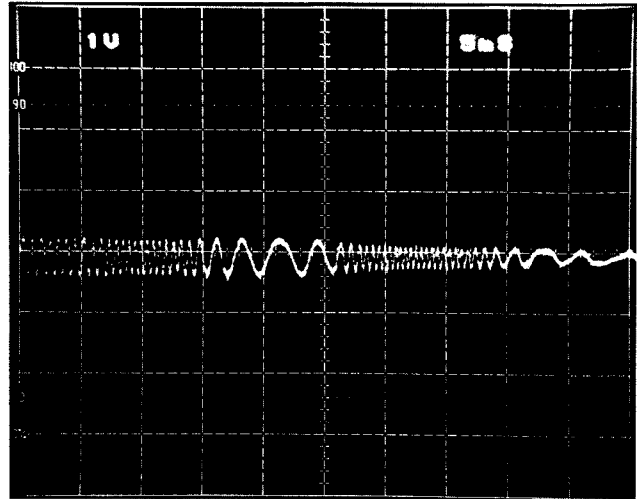
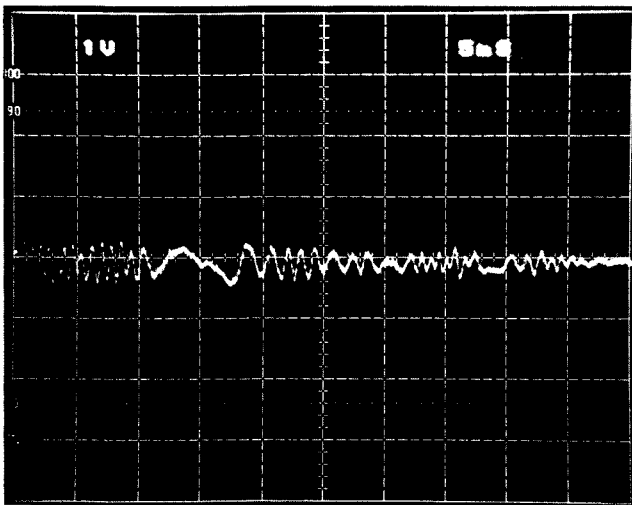

Fig. 9-6 Grating Adjustment



Photograph 9-2 NULL point



Photograph 9-3 Waveform beyond the NULL point

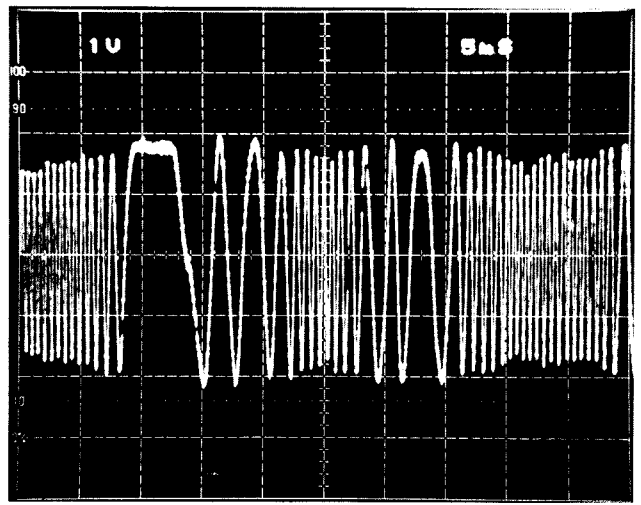

Photograph 9-4 Maximum amplitude

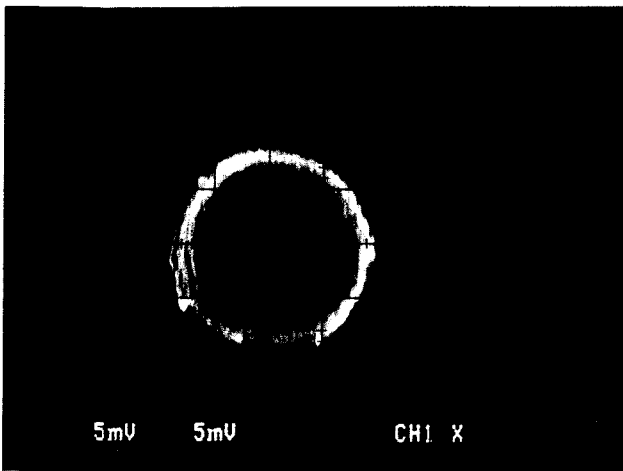

Photograph 9-5

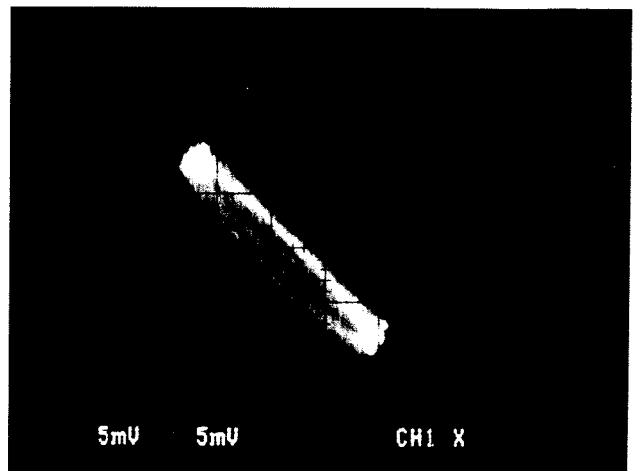

Photograph 9-6

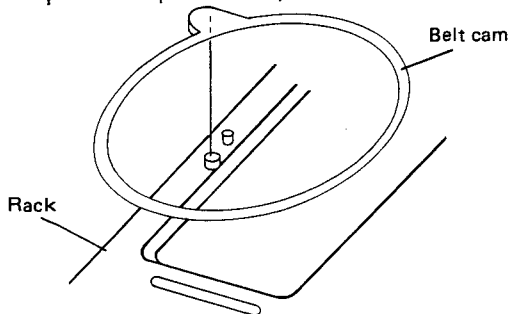
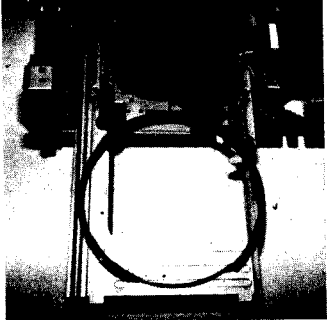
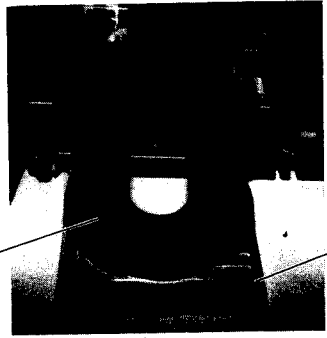
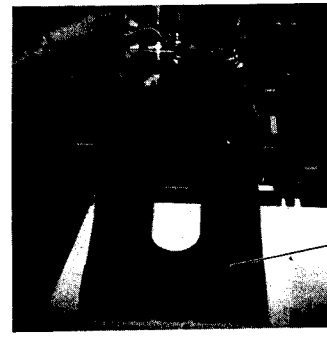
Step No.	Oscilloscope Setting		Test Points	Adjusting Points	Check items/ Adjustment specifications	Adjustment procedure
	V	H				
						 <p>Fig. 9-7 Align the stopper of the rack with the hole of the belt cam.</p>  <p>Photograph 9-7</p>  <p>Photograph 9-8</p>  <p>Photograph 9-9</p> <ul style="list-style-type: none"> • After grating adjustment is completed, install the disc tray according to the procedure below. • Disc Tray Installation <ol style="list-style-type: none"> 1. Pull out the slide base unit all the way. 2. Align the stopper (of the two, the front one) with the hole of the belt cam, (Fig. 9-7) as shown in Photograph 9-7. 3. Match the tray's peripheral stoppers with the four grooves of the belt cam installed in (2), and have the plate raised. (Insert the plate's stopper into the top of the belt cam's groove.) (See Photograph 9-8) 4. Insert the tray through the slide base unit. (Position by referring to the oval cutout of the plate.) 5. Insert the slide base unit's stoppers on the two holes on the front side of the tray. (See Photograph 9-9) 6. Secure the tray and lide base unit with two screws.

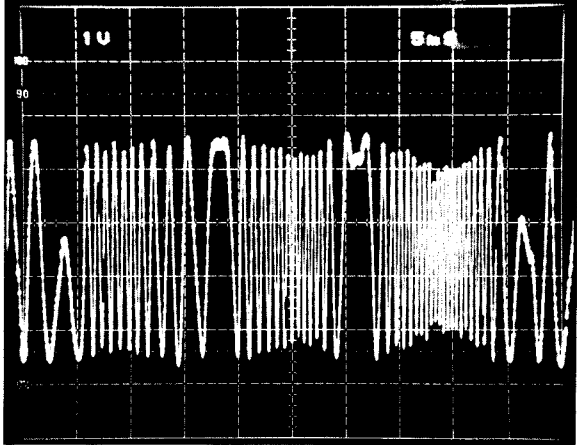
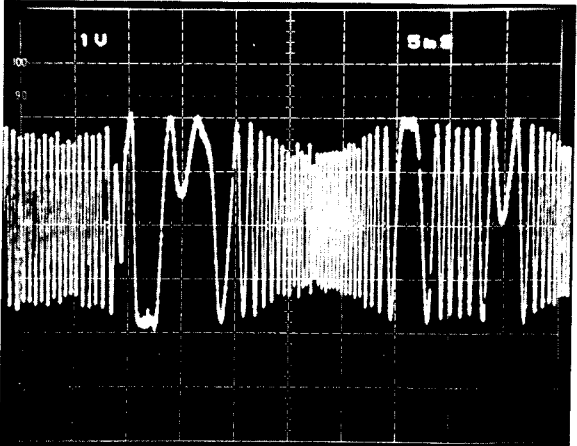
Step No.	Oscilloscope position		Test points	Adjustment positions	Check items/ Adjustment specifications	Adjustment procedure
	V	H				
5 TRACKING BALANCE ADJUSTMENT						
	1V/div	5msec /div	TP 1 Pin 4 (TR. ER)	VR 5 (TR. BL)		<ul style="list-style-type: none"> • Load the test disc. • Set the player to test mode (see page 33). • Move the carriage to a position near the center of the disc by using the MANUAL SEARCH FWD key (▷▷). • Press the TRACK FWD key (▷▷) and then the PLAY key (▷) to start the disc turning. • Observe TP1 pin 4 TR.ER (tracking error) in the oscilloscope, and eliminate the DC component of the tracking error by adjustment the VR5 TR.BL (tracking balance) control.
						 <p>Photograph 9-10 DC components included</p>
						 <p>Photograph 9-11 DC components excluded</p>

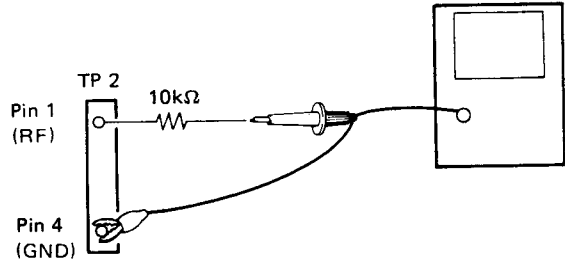
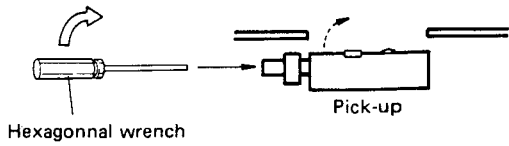
Step No.	Oscilloscope position		Test points	Adjustment positions	Check items/ Adjustment specifications	Adjustment procedure
	V	H				
6	TANGENTIAL ADJUSTMENT					
			200nS	TP2 pin 1 (RF output)	Tangential adjustment screw	Best eye pattern
						<ul style="list-style-type: none"> • Load the test disc. • Set the player to test mode (see page 33). • Using the MANUAL SEARCH FWD key (▷▷), move the pick-up to the disc edge to enable the tangential adjustment screw to be seen from the left hand side (see Fig. 9-9). • Press the TRACK FWD (▷▷), PLAY (▷), and PAUSE (⏸) keys in that order to close all servos, (The PAUSE indicator will light up.) • Observe the TP2 pin 1 RF (RF output) in the oscilloscope and adjust the tangential adjustment screw to obtain the clearest eye pattern. (Fig. 9-9). • The optimum position is the midpoint between the two positions where the eye pattern starts to deteriorate when the tangential adjustment screw is turned clockwise and counter clockwise. Guidelines for this adjustment: In addition to a clear overall waveform, adjust to obtain relatively slender lines (see photograph 9-12) Where single "diamond" shapes are formed in the eye pattern. • To make the waveform easier to observe, insert a 10 Kohm resistance (or 5 Kohm if the waveform is hard to see) in the tip of the probe as shown in Fig. 9-8.
						 <p style="text-align: center;">Fig. 9-8</p> <p><i>Note: When making adjustments, lift the pick up unit a little with a hexagonal wrench so that it can't fall down.</i></p> 

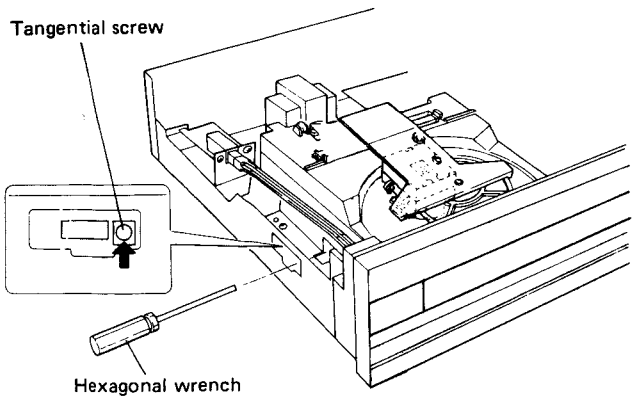
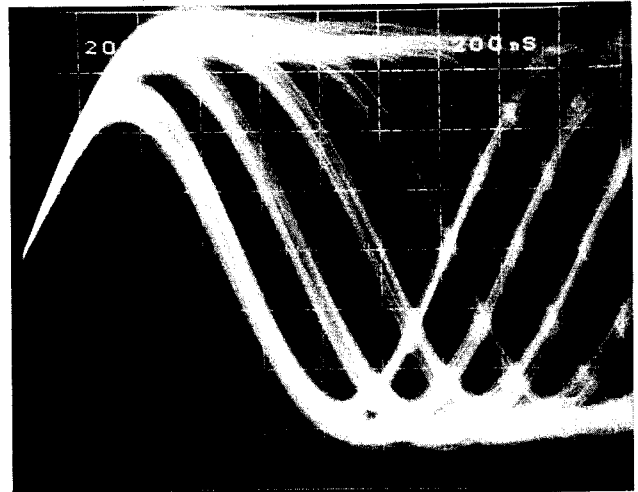
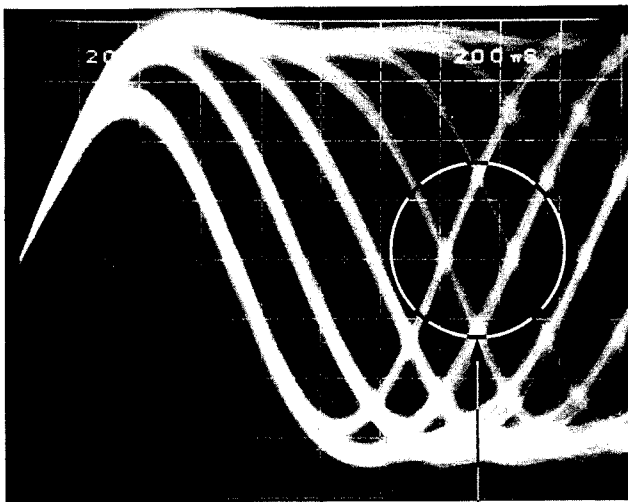

Fig. 9-9 Tangential Adjustment



Photograph 9-13



Observation point

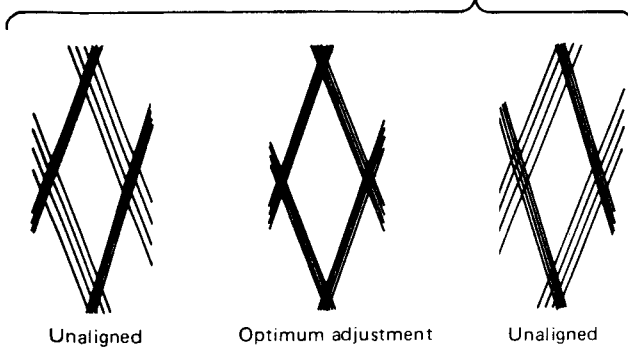

Unaligned

Optimum adjustment

Unaligned

Photograph 9-12

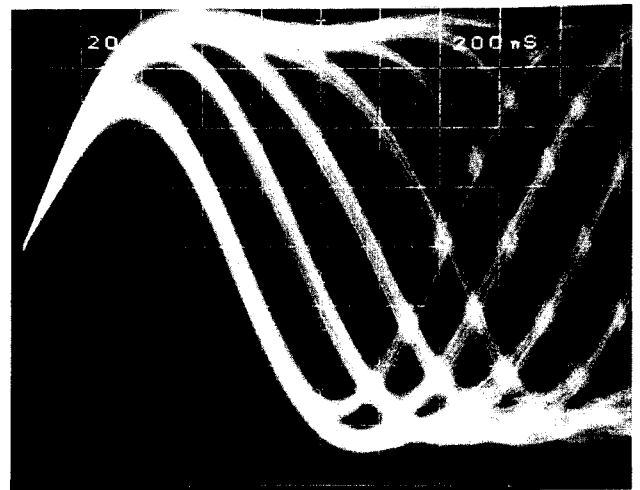

Photograph 9-15

Step No.	Oscilloscope position		Test points	Adjustment positions	Check items/ Adjustment specifications	Adjustment procedure
	V	H				
7	FOCUS GAIN ADJUSTMENT					
	20mV/div./5mV/div. CH1(X), CH2(Y) (Probe 10 : 1)		X-axis TP 5 Pin 1 (FO. IN) Y-axis TP 5 Pin 2 (FO. OT)	VR3 (FO. GA)	Phase difference 90°	<ul style="list-style-type: none"> • Turn the power off and connect the oscilloscope and oscillator as shown in Fig. 9-10. • Set the player to test mode (see page 33). • Press, in this order, the TRACK FWD (▷▷), PLAY (▷), and PAUSE (⏏) keys. Turn on the servos for the focus, spindle, and tracking. • Turn on the power for the oscillator and output 875Hz 0.5Vp-p. <p>NOTE: Since there are cases where DC is output by the oscillator during POWER ON, it is advisable to connect OSC after turning the power on.</p> <ul style="list-style-type: none"> • Adjust the oscilloscope's Lissajous waveform into a circle (phase difference 90) shown in photograph 9-17. Then adjust the volume of VR3 FO. GA (focus gain).
	<p>Fig. 9-10 Connection of the oscilloscope to an oscillator</p>					

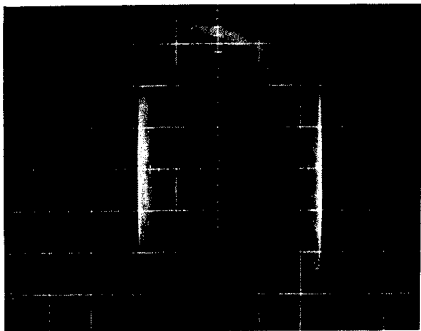

Photograph 9-16 Gain too large

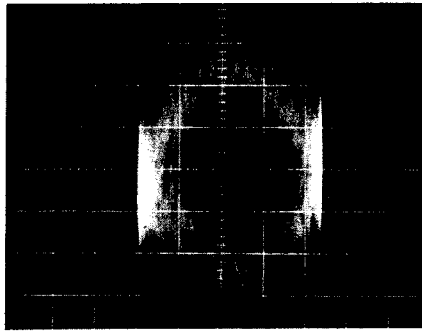

Photograph 9-17 Gain optimum

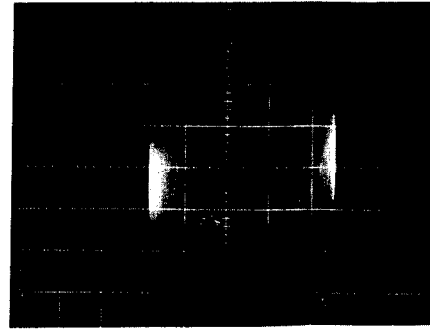

Photograph 9-18 Gain too small

Step No.	Oscilloscope position		Test points	Adjustment positions	Check items/ Adjustment specifications	Adjustment procedure
	V	H				
8	TRACKING ADJUSTMENT					
	50mV/div./10mV/div. CH1(X), CH2(Y) (Probe 10 : 1)		X-axis TP 5 Pin 5 (TR. IN) Y-axis TP 5 Pin 4 (TR. OT)	VR4 (TR. GA)	Phase difference 90°	<ul style="list-style-type: none"> • Turn the power off and connect the oscilloscope and oscillator as shown in Fig. 9-11 • Set the player to test mode (see page 33). • Press, in this order, the TRACK FWD (▷▷), PLAY (▷), and PAUSE (⏸) keys. Turn on the servos for the focus, spindle, and tracking. • Turn on the power for the oscillator and output 800Hz 0.5Vp-p. <p>NOTE: Since there are cases where DC is output by the oscillator during POWER ON, it is advisable to connect OSC after turning the power on.</p> <ul style="list-style-type: none"> • Adjust the oscilloscope's Lissajous waveform into a circle (phase difference 90°) shown in photograph 9-20. Then adjust the volume of VR4 TR. GA (Tracking gain).

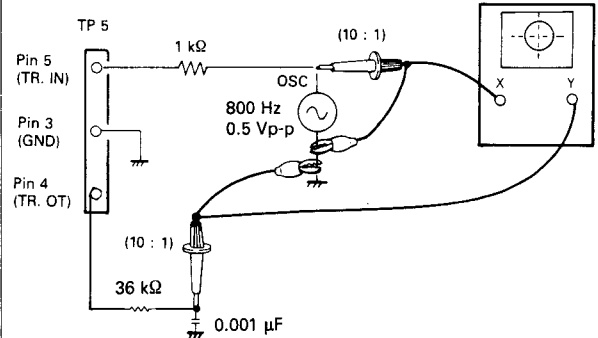
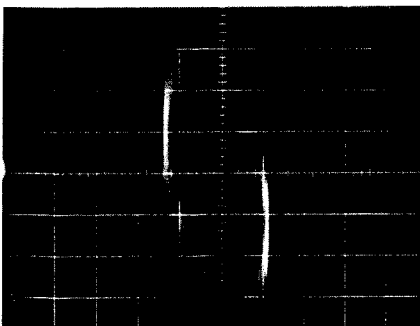
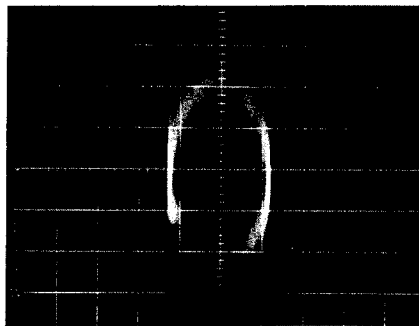

Fig. 9-11 Connection of the oscilloscope to an oscillator





Photograph 9-19 Gain too large

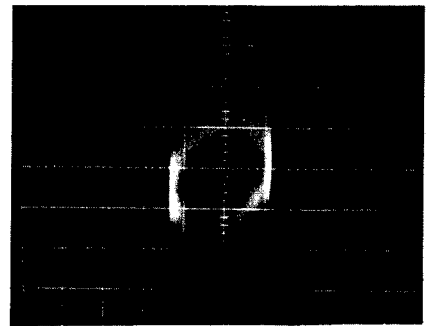

Photograph 9-20 Gain optimum



Photograph 9-21 Gain too small

Step No.	Oscilloscope position		Test points	Adjustment positions	Check items/ Adjustment specifications	Adjustment procedure
	V	H				
9	VCO FREE-RUN FREQUENCY ADJUSTMENT					
	0.5V/div	5mS/div.	VCO TP jumper		Write the Center Value of the Waveform	<ul style="list-style-type: none"> ● Insert a test disc. ● Set the player to test mode (see page 33). ● Press the TRACK FWD () and PLAY () keys in that order to close the focus and spindle servos. ● Then look at the waveform of the VCO TP jumper wire on an oscilloscope. (V : 0.5V/div.) ● Record the central value of the VCO TP jumper wire waveform. ● Using the core driver, adjust the VL1 (VCO coil) core so that the center value of the oscilloscope waveform is the same as the previously recorded value when the PAUSE key () is pressed to switch the tracking servo on.
	0.5V/div	5mS/div.	VCO TP jumper	VL 1 (VCO coil)		

9. RÉGLAGE

Les réglages du lecteur de disque compact s'effectuent de la manière suivante:

● Items de Réglage

1. Réglages de décalage d'alignement et de mise au point
2. Vérification de la puissance du LD (diode au laser)
3. Réglage de varrouillage de mise au point et de l'axe
4. Réglage de la mire
5. Réglage de l'équilibre d'alignement
6. Réglage tangentiel
7. Réglage du gain de mise au point
8. Réglage du gain d'alignement
9. Réglage de la fréquence de fonctionnement libre VCO

● Equipement de mesure

1. Oscilloscope de trace double
2. Indicateur de puissance optique
3. Disque d'essai (YEDS7)
4. Filtres de réglage de mise au point et d'alignement
5. Filtre passe-bande de réglage du gain de boucle
6. Générateur de signal
7. Tournevis de mire
8. Autres équipements de mesure d'usage courant

● Mode d'essai

Les réglages du lecteur de disque s'effectuent en mode d'essai.

Procédures de réglage et d'annulation du mode d'essai

- (1) Après avoir court-circuité les fils de liaison de mode d'essai avec une paire de pinces ou un objet similaire, enclencher l'interrupteur POWER (S401).
- (2) Puis, mettre en route le commutateur MANUAL SEARCH FWD (RECHERCHE MANUELLE EN AVANT) (<<) ou le commutateur REV (MARCHÉ ARRIÈRE) (>>) pour mettre en fonction le mode d'essai.
- (3) Le mode d'essai est annulé en mettant hors de service le commutateur POWER.

Les diverses fonctions des touches au cours du mode d'essai sont indiquées dans le tableau 9-1.

● Commandes de Réglage

- VR7: Décalage d'alignement (TR, OF)
- VR3: Gain de mise au point (FO, GA)
- VR4: Gain d'alignement (TR.GA)
- VR5: Equilibre d'alignement (TR.BL)
- VR6: Décalage de mise au point (FO/OF)
- VL1: VCO fréquence

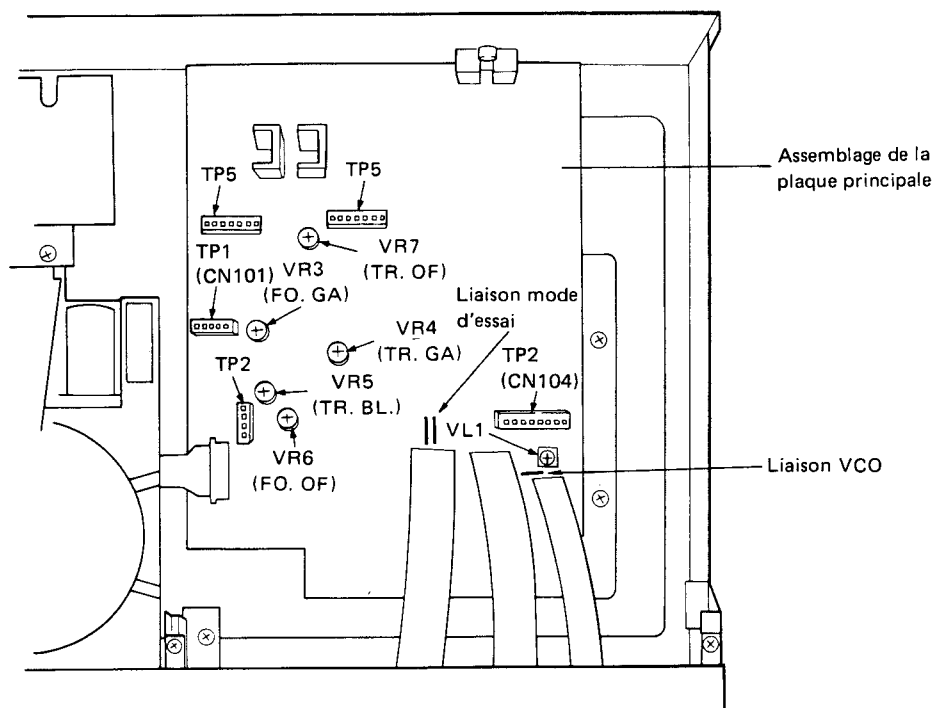

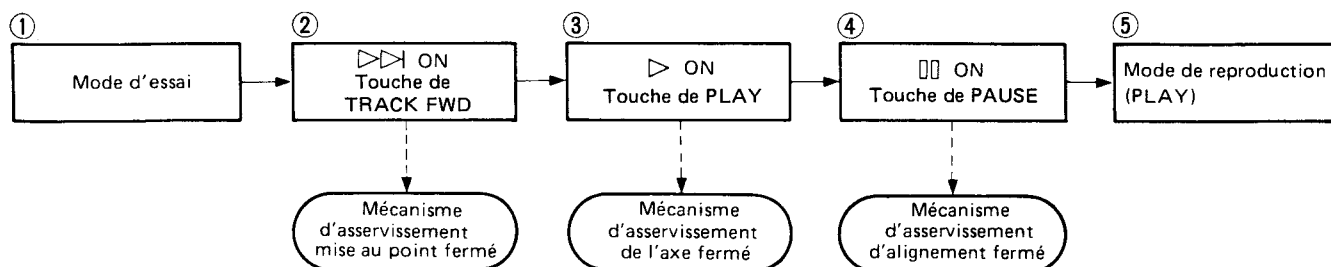

Fig. 9-1 Points de réglage

Au cours du mode d'essai, chaque mécanisme d'asservissement peut être fermé ou ouvert à travers des opérations différentes. Par conséquent, chaque mécanisme d'asservissement doit être fermé un à la fois (en séquence de série) pour régler le

mode de reproduction. Il faudrait remarquer que le mode de reproduction n'est pas mis en fonction en pressant tout simplement la touche de PAUSE () au cours du mode d'essai.









Exemple: Commuter du mode d'arrêt au mode de reproduction.



- Cada servo del modo de prueba estará en secuencia en serie.

• Fonctions des touches en mode d'essai

Tableau 9-1 Fonctions des touches

Symbole	Touche	Fonction durant le mode d'essai	Description
	TRACK BACK	La diode laser s'allume	Orifice de réglage de gradation
	TRACK FWD (Alignement en avant)	Mécanisme asservissement fermé	La diode laser s'allume, l'actionneur de mise au point se déplace vers le haut/le bas, et le mécanisme d'asservissement de mise au point se ferme.
	PLAY (Reproduction)	Mécanisme d'asservissement fermé	Mécanisme d'asservissement fermé en mode CLV-A après avoir démarré de moteur de l'axe.
	PAUSE	Mécanisme d'asservissement d'alignement fermé/ouvert	Le mécanisme d'asservissement se ferme en pressant le tumbler et le lecteur est commuté en mode de reproduction (avec les mécanismes d'asservissement de mise au point et de l'axe fermés). Le voyant PAUSE s'allume et le mécanisme d'asservissement est ouvert en pressant une deuxième fois.
	MANUAL SEARCH REV (Recherche manuelle en marche arrière)	Marche arrière du chariot (vers le centre du disque)	Le chariot est déplacé vers le centre du disque à une vitesse élevée d'environ 1 cm/seconde. Comme il n'y a aucun mécanisme de sécurité pour arrêter le chariot, ne pas le déplacer trop loin.
	MANUAL SEARCH FWD (Recherche manuelle en avant)	Marche avant du chariot (vers le bord du disque)	Le chariot se déplace vers le bord du disque à une vitesse élevée d'environ 1 cm/seconde. Comme il n'y a aucun mécanisme de sécurité pour arrêter le chariot, ne pas le déplacer trop loin.
	REPEAT (Répétition)	L'objectif se déplace vers le haut/le bas.	La diode laser s'allume, et l'actionneur de mise au point est déplacé vers le haut/vers le bas. Le mécanisme d'asservissement de mise au point n'est pas fermé.
	STOP (Arrêt)	Arrêt	Tous les mécanisme d'asservissement sont arrêtés et réenclenchés à l'état d'origine.
	OUVERT/FERME	(Plateau de disque)	Le plateau de disque est ouvert/fermé. Il faudrait remarquer que le pick-up ne retourne pas sur le support du bras de pick-up quand le plateau est ouvert, et reste sur la même position lorsque le plateau est fermé.

No. d'étape	Position de l'oscilloscope		Points d'essai	Positions de réglage	Items de contrôle/ Spécifications de réglage	Procédure de réglage
	V	H				
1 REGLAGES DE DECALAGE D'ALIGNEMENT ET DE MISE AU POINT						
			TP1 Broche 2 (FO.ER)	VR 7 (TR. OF)	0V ± 10mV	<ul style="list-style-type: none"> Régler le lecteur en mode d'essai (se référer à la page 46). Régler la tension sur TP1 broche 2 TR.RT (retour d'alignement) à une valeur de 0 V ± 10 mV en tournant la commande de VR7 TR.OF (décalage d'alignement). Régler la tension sur TP1 broche 5 FO.ER (erreur de mise au point) sur une valeur de 0 V ± 10 mV en tournant la commande de VR6 FO.OF (décalage de mise au point). <p><i>Note: Lors de l'ajustement de VR7, faire attention à ne pas créer un court circuit entre VR7 et le radiateur IC7 (prendre la précaution d'isoler le tournevis).</i></p>
			TP1 Broche 5 (TR.RT)	VR 6 (FO.OF)	0V ± 10mV	
2 VERIFICATION DE LA PUISSANCE DU LD (DIODE AU LASER)						
				VR1	Valeur nominale spécifiée	<ul style="list-style-type: none"> Póngalo en el modo de prueba. (Consulte la página 46.) Presione la tecla TRAKC BACK, y energice el diodo de laser (LD). Coloque el sensor del medidor de potencia óptica directamente sobre el objetivo, y compruebe si la potencia del LD cumple el valor estándar (0,21 mW ±0,02 mW). Si la potencia del LD no cumple el valor estándar, ajústela con el control de ajuste de la potencia del LD (dentro del conjunto del captor). Después de ajustar la potencia del LD, ponga en reproducción un disco de prueba (YEDS7), y mida la tensión entre picos (p-p) de la forma de onda de RF. Si la tensión p-p de la forma de onda de RF supera los 1,5V, ajuste la pontencia del LD de forma que dicha tensión sea de aproximadamente 1,5V.
3 VERIFICATIONS DEVERROUILLAGE DE MISE AU POINT ET DE L'AXE						
	V 0,5 V/div.	H 100ms/div.	TP2 Broche 1 (sortie RF)		Sortie RF générée Rotation normale	<ul style="list-style-type: none"> Charger le disque d'essai. Régler le lecteur en mode d'essai (se référer à la page 46). Presser la touche MANUAL SEARCH FWD pour déplacer le pick-up à proximité du centre du disque. Il faudrait noter que cette étape devrait être exécutée. Observer TP2 Broche 4 RF (sortie RF) au moyen de l'oscilloscope pour vérifier si un signal de sortie RF est généré lorsque la touche TRACK FWD (▷◁) est pressée. Presser la touche PLAY (▷) et vérifier si le disque tourne à une vitesse normale (environ 300 tours/minute à proximité du centre du disque) dans la direction correcte (dans le sens des aiguilles d'une montre).

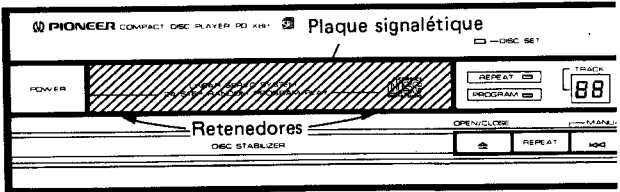
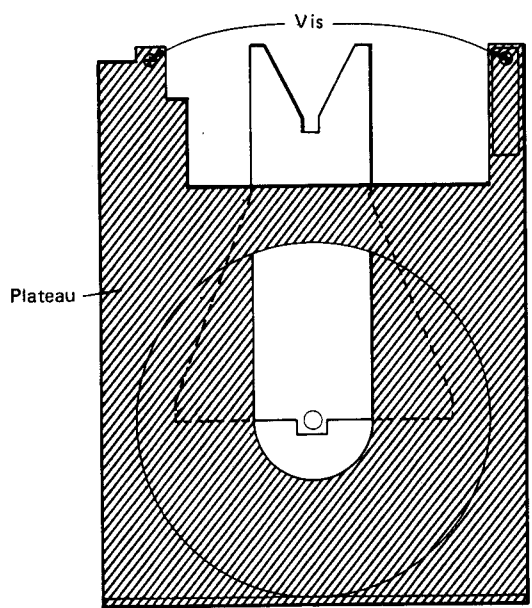
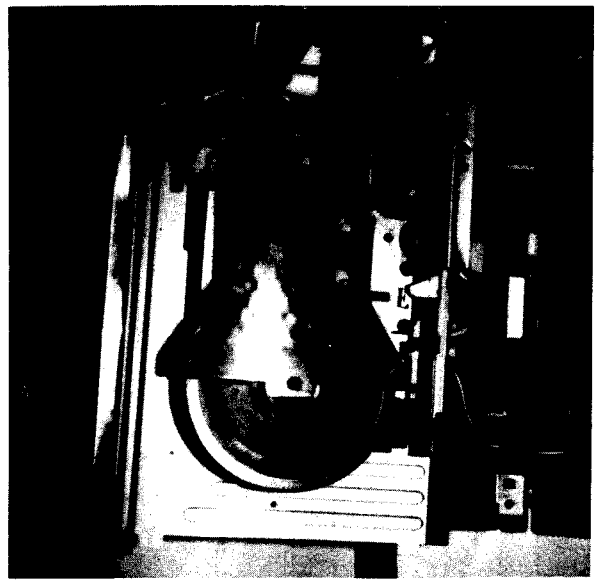
No. d'étape	Position de l'oscilloscope		Points d'essai	Positions de réglage	Items de contrôle/ Spécifications de réglage	Procédure de réglage
	V	H				
						<ul style="list-style-type: none"> • Effectuer ce réglage après avoir enlevé le plateau de disque. • Retrait du plateau de disque <ol style="list-style-type: none"> 1. Mettre sous tension et retirer le plateau de disque. 2. Retirer les deux butées inférieures et tirer la plaque signalétique vers le haut pour l'enlever (Fig. 9-2). 3. Déposer le panneau avant. 4. Retirer les deux vis de fixation du plateau et l'unité de base coulissante (Fig. 9-3). 5. Sortir le plateau, la plaque et la came de courroie en les faisant coulisser le long de la glissière (Fig. 9-3). <ul style="list-style-type: none"> • La photographie 9-1 présente l'appareil lorsque le plateau de disque a été retiré en suivant les démarches 6.1 à 6.5. • Il est maintenant possible d'effectuer le réglage de la diffraction.
						 <p>Retirer la plaque signalétique</p> <p>Fig. 9-2</p>  <p>Enlever les deux vis de fixation du plateau de disque et retirer le plateau de disque.</p> <p>Fig. 9-3</p>
						 <p>Photographie 9-1 Sans le plateau de disque.</p>

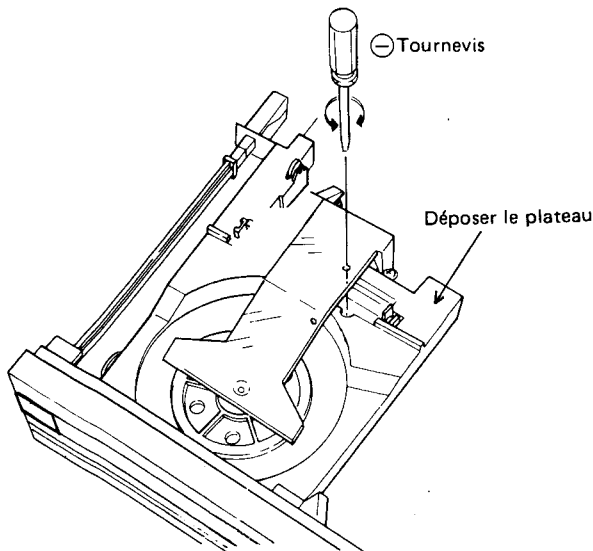
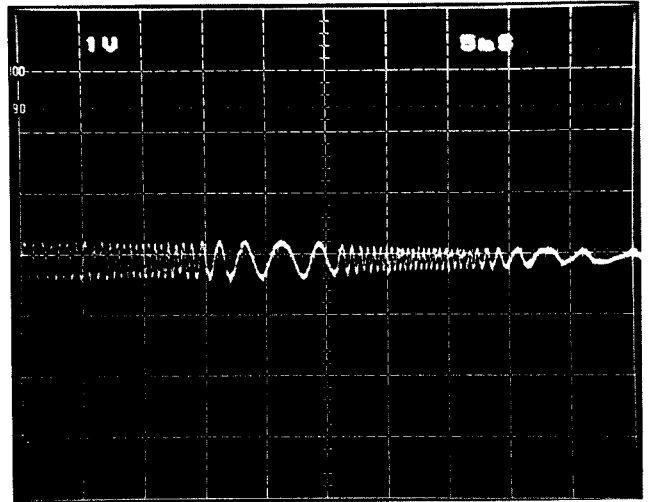
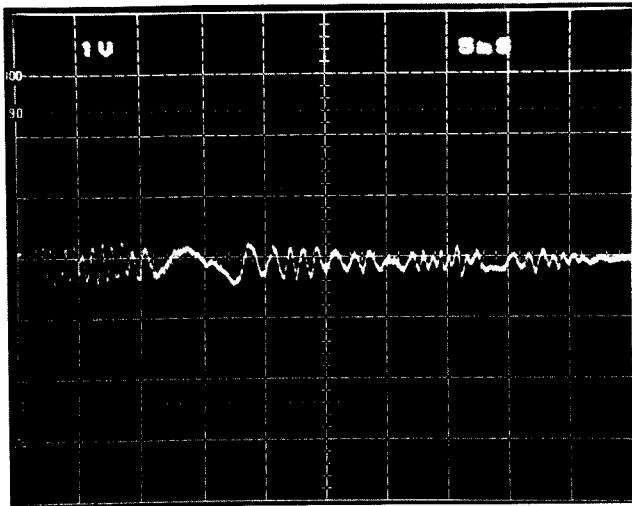

Fig. 9-6 Réglage de la mire



Photographie 9-2 Point NULL



Photographie 9-3 Forme d'ondes au-delà du point NULL

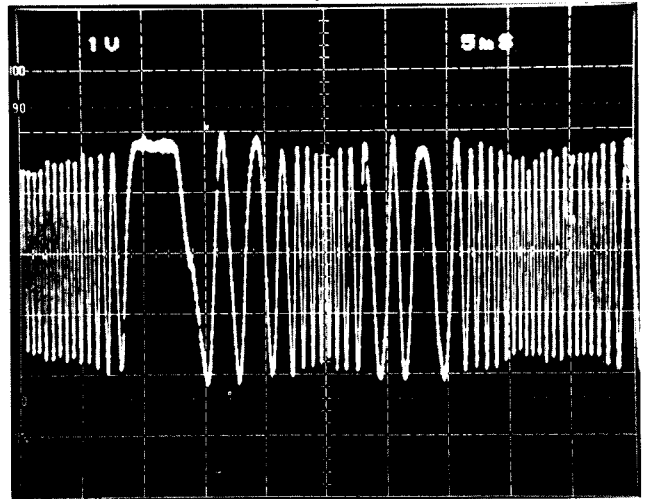

Photographie 9-4 Amplitude maximum

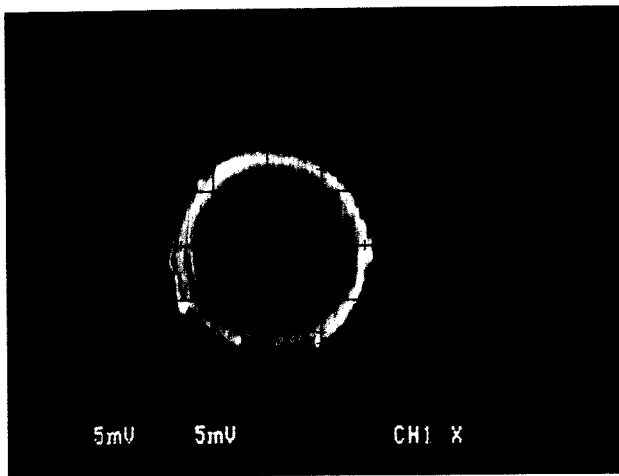

Photographie 9-5

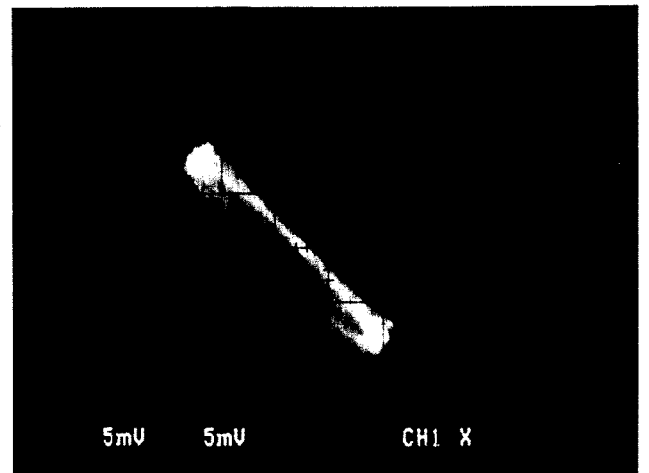

Photographie 9-6

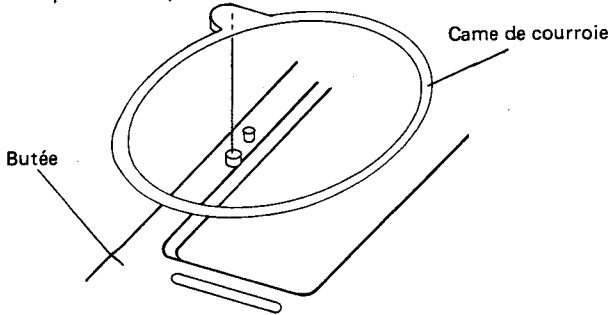
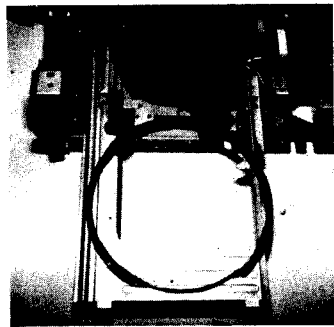
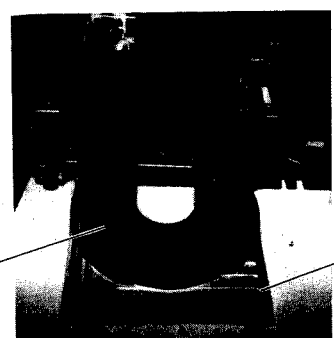
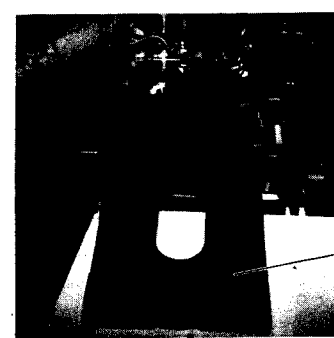
No. d'étape	Position de l'oscilloscope		Points d'essai	Positions de réglage	Items de contrôle/Spécifications de réglage	Procédure de réglage
	V	H				
						 <p>Fig. 9-7 Aligner la butée de l'étagère avec l'orifice de la came de courroie.</p>  <p>Photographie 9-7</p>  <p>Photographie 9-8</p>  <p>Photographie 9-9</p> <ul style="list-style-type: none"> • Une fois le réglage de la diffraction effectué, installer le plateau de disque en suivant la démarche suivante. • Installation du plateau de disque <ol style="list-style-type: none"> 1. Sortir, en la tirant complètement vers l'extérieur, l'unité de base coulissante. 2. Aligner la butée (celle à l'avant) avec l'orifice de la came de la courroie (Fig. 9-7) comme illustré dans la photographie 9-7. 3. Faire correspondre les butées périphériques du plateau avec les quatre rainures de la came de courroie installée dans (2), et élever la plaque (insérer la butée de la plaque dans la partie supérieure de la rainure de la came de courroie). (Voir la photographie 9-8) 4. Insérer le plateau par l'unité de base coulissante (le positionner en se référant à la découpe ovale de la plaque). 5. Insérer les butées de l'unité de base coulissante dans les deux orifices situés à l'avant du plateau. 6. Serrer le plateau et l'unité de base coulissante avec deux vis.

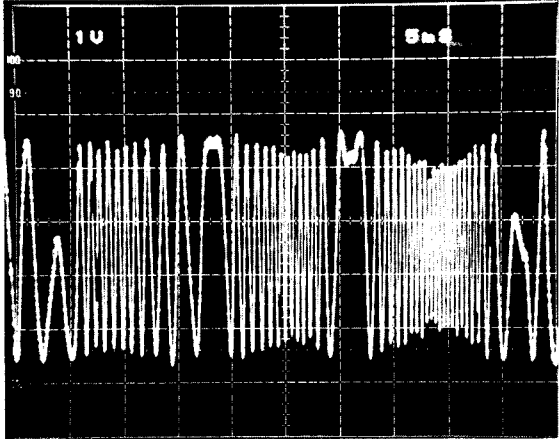
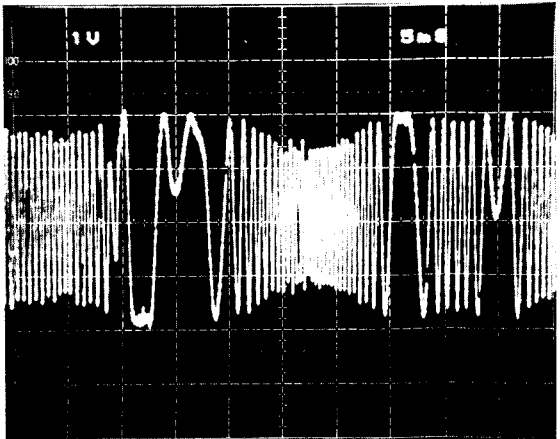
No. d'étape	Position de l'oscilloscope		Points d'essai	Posotions de réglage	Items de contrôle/ Spécifications de réglage	Procédure de réglage
	V	H				
5	REGLAGE DE L'EQUILIBRE D'ALIGNEMENT					
	1 V/div.	5 ms/div.	TP1 Broche 4 (TR.ER)	VR 5 (TR. BL)		<ul style="list-style-type: none"> • Charger le disque d'essai. • Régler le lecteur en mode d'essai (se référer à la page 46). • Déplacer le chariot à une position à proximité du centre du disque en utilisant la touche MANUAL SEARCH FWD (▷▷). • Presser la touche TRACK FWD (▷▷), puis la touche PLAY (▷) pour faire tourner le disque. • Observer TP1 Broche 4 TR.ER (erreur d'alignement) dans l'oscilloscope, et éliminer la composante CC de l'erreur d'alignement en réglant la commande VR5 TR.BL (équilibre d'alignement).
						 <p>Photographie 9-10 Composantes CC comprises</p>  <p>Photographie 9-11 Composantes CC exclues</p>

No. d'étape	Position de l'oscilloscope		Points d'essai	Positions de réglage	Items de contrôle/Spécifications de réglage	Procédure de réglage
	V	H				
6	REGLAGE TANGENTIEL					
			200nS TP2 Broche 1 (sortie RF)	Vis de réglage tangentiel	Meilleur modèle de vue	<ul style="list-style-type: none"> • Charger le disque d'essai. • Régler le lecteur en mode d'essai (se référer à la page 46). • Déplacer le pick-up au bord du disque, en utilisant la touche MANUAL SEARCH FWD (▷), pour pouvoir observer la vis de réglage tangentiel à partir du côté gauche (se référer à la Fig. 9-9). • Presser les touches TRACK FWD (▷◁), PLAY (▷) et PAUSE (⏏) selon cet ordre, pour fermer tous les mécanismes d'asservissement. (Dans ce cas le voyant PAUSE s'allumera). • Observer TP2 broche 1 RF (sortie RF) dans l'oscilloscope et régler la vis de réglage tangentielle pour obtenir le modèle de vue le plus net. (Se référer à la Fig. 9-9). • La position optimale est un point intermédiaire entre les deux positions pour lesquelles le modèle de vue commence à se détériorer lorsque l'on tourne la vis de réglage dans le sens des aiguilles d'une montre et dans le sens contraire. Conseils pour ce réglage: Outre une forme d'ondes d'ensemble claire, régler pour obtenir des lignes relativement fines (se référer à la photographie 9-12), sur lesquelles des formes en "diamant" simple sont observées dans le modèle de vue. • Pour faciliter l'observation de la forme d'ondes, introduire une résistance de 10 Kohms (ou 5 Kohms s'il est difficile d'observer la forme d'ondes) dans le bout de la sonde comme indiqué par la Fig. 9-8.
						<p style="text-align: center;">Fig. 9-8</p> <p><i>Note: Lors des réglages, relever un peu le capteur avec une clé hexagonale de façon à ce qu'il ne tombe pas.</i></p>

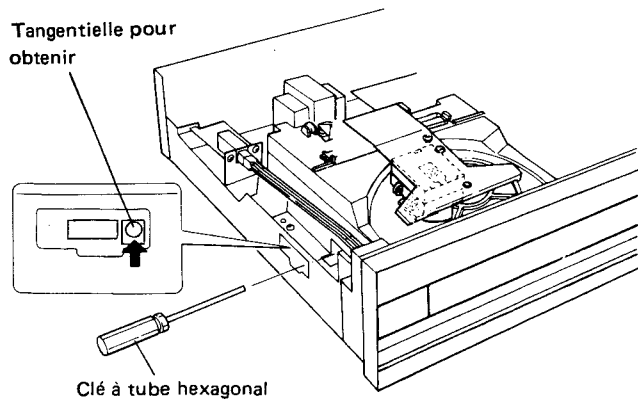
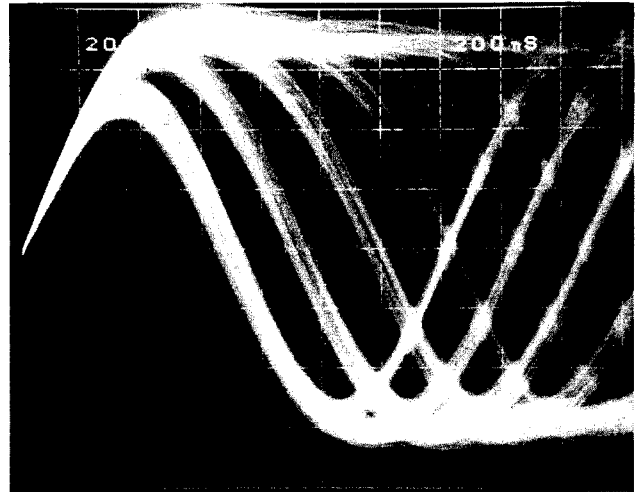
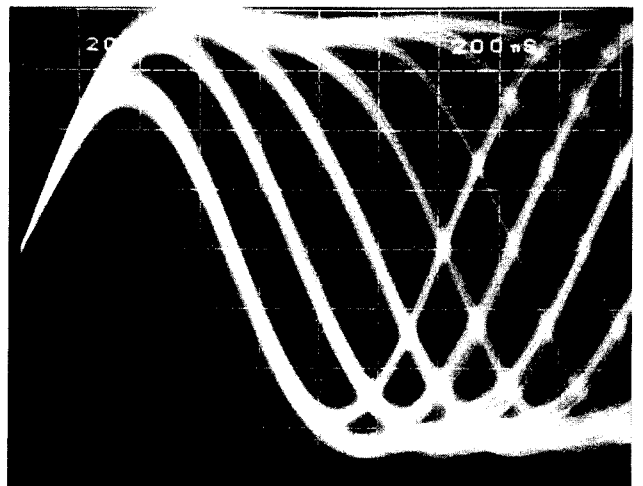

Fig. 9-9 Réglage tangentiel



Photographie 9-13



Photographie 9-14

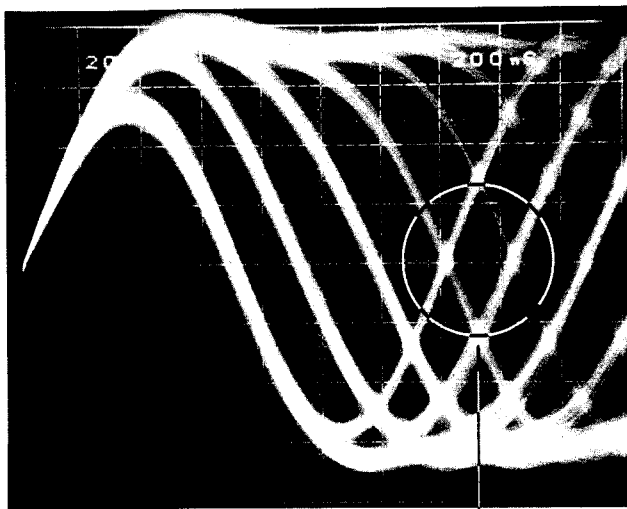

Point d'observation

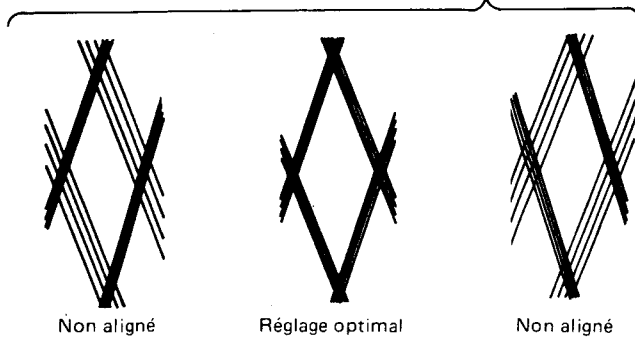

Non aligné

Réglage optimal

Non aligné

Photographie 9-12

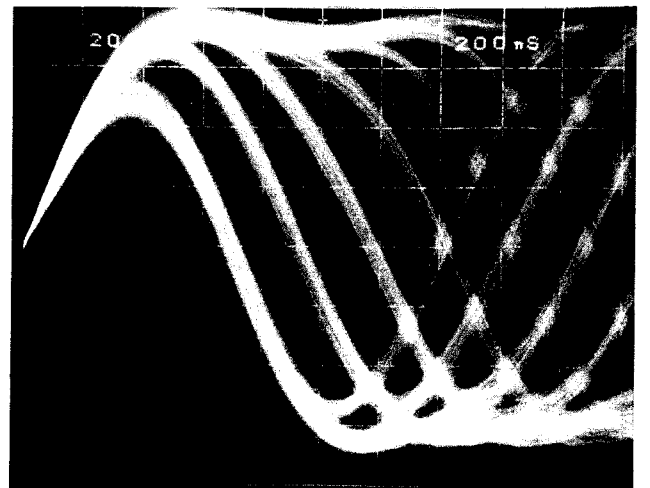

Photographie 9-15

No. d'étape	Position de l'oscilloscope		Points d'essai	Positions de réglage	Items de contrôle/Spécifications de réglage	Procédure de réglage
	V	H				
7	REGLAGE DU GAIN DE MISE AU POINT					
	20mV/div./5mV/div. CH1(X), CH2(Y) (Sonde 10 : 1)		Axe X TP 5 Broche 1 (FO. IN) Axe Y TP 5 Broche 2 (FO. OT)	VR 3 (FO. GA)	Différence de phase de 90°	<ul style="list-style-type: none"> • Mettre l'appareil hors tension et raccorder l'oscilloscope et l'oscillateur comme illustré à la Fig. 9-10. • Régler le lecteur en mode d'essai (se référer à la page 46). • Appuyer, successivement, sur les touches TRACK FWRD, PLAY et PAUSE. Mettre les servomécanismes en marche pour la mise au point, l'axe et l'alignement. • Mettre l'oscillateur sous tension et sortir 875Hz 0,5Vc-c. <p><i>Note: Etant donné que, dans certains cas, le courant continu est fourni par l'oscillateur alors que l'alimentation est fournie, il est recommandé de connecter OSC après avoir fourni l'alimentation.</i></p> <ul style="list-style-type: none"> • Ajuster la forme d'onde Lissajous de l'oscilloscope pour obtenir un cercle (90 de différence de phase) comme illustré dans la photographie 9-17. Ensuite, ajuster le volume de VR3 FO. GA (gain de mise au point).

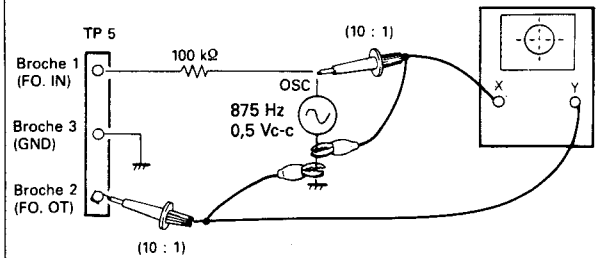
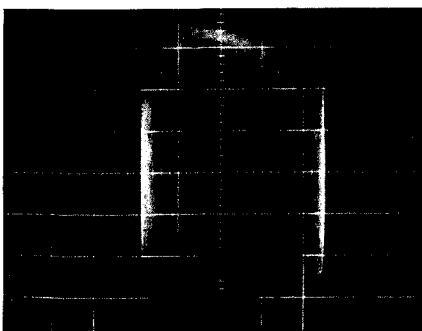
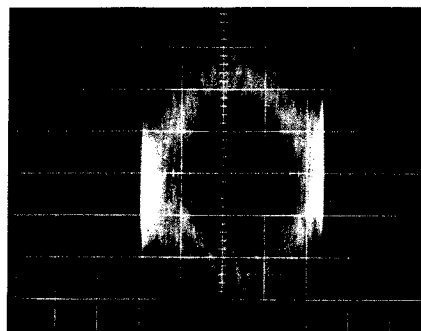

Fig. 9-10 Connexion de l'oscilloscope à un oscillateur



Photographie 9-16 Gain trop haut



Photographie 9-17 Gain optimal

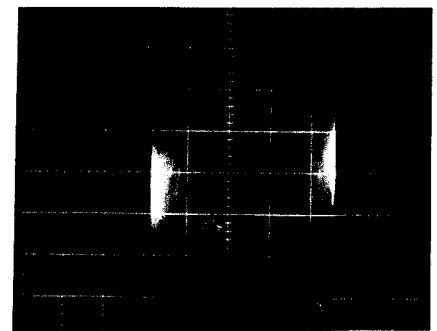

Photographie 9-18 Gain trop bas

No. d'étape	Position de l'oscilloscope		Points d'essai	Positions de réglage	Items de contrôle/Spécifications de réglage	Procédure de réglage
	V	H				
8	REGLAGE DE GAIN D'ALIGNEMENT					<ul style="list-style-type: none"> • Mettre l'appareil hors tension et raccorder l'oscilloscope et l'oscillateur comme illustré à la Fig. 9-11. • Régler le lecteur en mode d'essai (se référer à la page 46). • Appuyer, successivement, sur les touches TRACK FWRD, PLAY et PAUSE. Mettre les servomécanismes en marche pour la mise au point, l'axe et l'alignement. • Mettre l'oscillateur sous tension et sortir 800Hz 0,5Vc-c. <p><i>Note: Etant donné que, dans certains cas, le courant continu est fourni par l'oscillateur alors que l'alimentation est fournie, il est recommandé de connecter OSC après avoir fourni l'alimentation.</i></p> <ul style="list-style-type: none"> • Ajuster la forme d'onde Lissajous de l'oscilloscope pour obtenir un cercle (90° de différence de phase) comme illustré dans la photographie 9-20. Ensuite, ajuster le volume de VR4 TR. GA (gain d'alignement).
	50mV/div./10mV/div. CH1(X), CH2(Y) (Sonde 10 : 1)		Axe X TP 5 Broche 4 (TR. IN) Axe Y TP 5 Broche 5 (TR. OT)	VR 4 (TR. GA)	Différence de phase de 90°	<p>Fig. 9-11 Connexion de l'oscilloscope à un oscillateur</p>

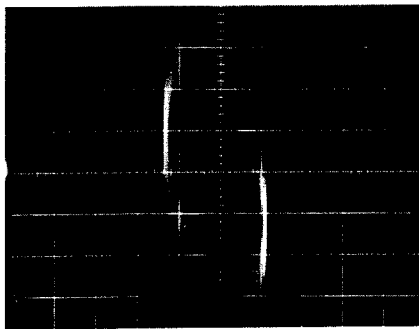

Photographie 9-19 Gain trop haut

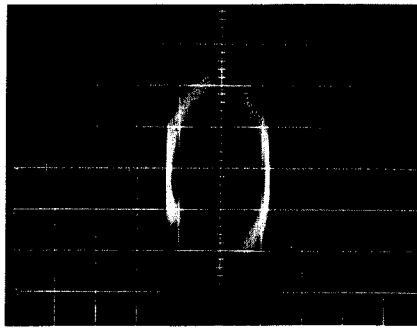

Photographie 9-20 Gain optimal

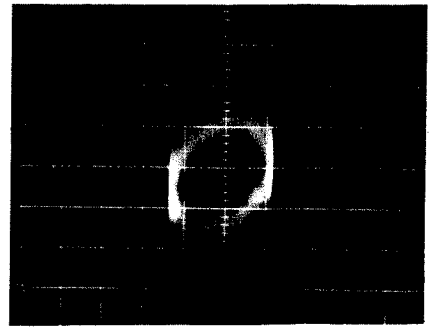

Photographie 9-21 Gain trop bas

No. d'étape	Position de l'oscilloscope		Points d'essai	Positions de réglage	Items de contrôle/Spécifications de réglage	Procédure de réglage
	V	H				
9	REGLAGE DE LA FREQUENCE DE FONCTIONNEMENT LIBRE VCO					
	0,5 V/div.	5mS/div.	Liaison VCO TP		Ecrire la valeur intermédiaire de la forme d'ondes.	<ul style="list-style-type: none"> • Insérer un disque étalon. • Régler le lecteur en mode d'essai (se référer à la page 46). • Presser les touches TRACK FWD (▷▷) et PLAY (▷), selon cet ordre, pour fermer les mécanismes d'asservissement de mise au point et de l'axe. • Ensuite, observer la forme d'onde du fil de liaison VCO TP sur un oscilloscope. (V : 0,5V/div.) • C47, R83, R87, etc. sont connectés à la broche 7, mais il est plus facile d'observer si la mesure de la tige de C47 est effectuée. • Enregistrer la valeur centrale de la forme d'onde du fil de liaison VCO TP. • En utilisant le driver de noyau, régler le noyau VL1 (bobine VCO) de telle manière que la valeur intermédiaire de la forme d'ondes de l'oscilloscope soit identique à la valeur enregistrée précédemment lorsque la touche PAUSE (□) a été pressée pour mettre en route les mécanismes d'asservissement d'alignement.
	0,5 V/div.	5mS/div.	Liaison VCO TP	Bobine VL1 (VCO)		

9. AJUSTE

Los ajustes del Tocado Compacto se ejecutan en el siguiente orden:

● Items de Ajuste

1. Ajustes de desalineación y desenfoque.
2. Verificación de energía del LD (diodo láser)
3. Verificación del seguro del foco y del seguro del eje
4. Ajuste de la mira
5. Ajuste de equilibrio de alineación
6. Ajuste tangencial
7. Ajuste de ganancia de foco
8. Ajuste de ganancia de alineación
9. Ajuste de frecuencia de operación libre VCO

● Equipo de Medición

1. Osciloscopio de alineación dual
2. Medidor de energía óptico
3. Disco de prueba (YEDS7)
4. Filtros de ajuste de foco y alineación
5. Filtro de paso de banda para ajuste de ganancia de bucle
6. Generador de señales
7. Colocador de mira
8. Otros equipos de medición de uso común

● Mode de prueba

Los ajustes del tocadiscos se llevan a cabo en el modo de prueba.

Procedimientos de colocación y cancelación del modo de prueba

- (1) Después de cortocircuitar los hilos de puente para el modo de prueba con un par de pinzas o un instrumento similar, ponga en ON el interruptor POWER SW (S401).
- (2) Luego, encender el conmutador MANUAL SEARCH FWD (BUSQUEDA MANUAL HACIA ADELANTE) (▷▷) o el conmutador REV (REVERSA) (◁◁) para activar el modo de prueba.
- (3) El modo de prueba se cancela colocando el conmutador POWER en la posición apagado.

En la Tabla 9-1 se listan las variadas funciones de tecla.

● Controles de ajuste

- VR7: Desalineación (TR. OF)
- VR3: Ganancia de foco (FO. GA)
- VR4: Ganancia de alineación (TR. GA)
- VR5: Equilibrio de alineación (TR. BL.)
- VR6: Desenfoque (FO. OF)
- VL1: VCO frecuencia

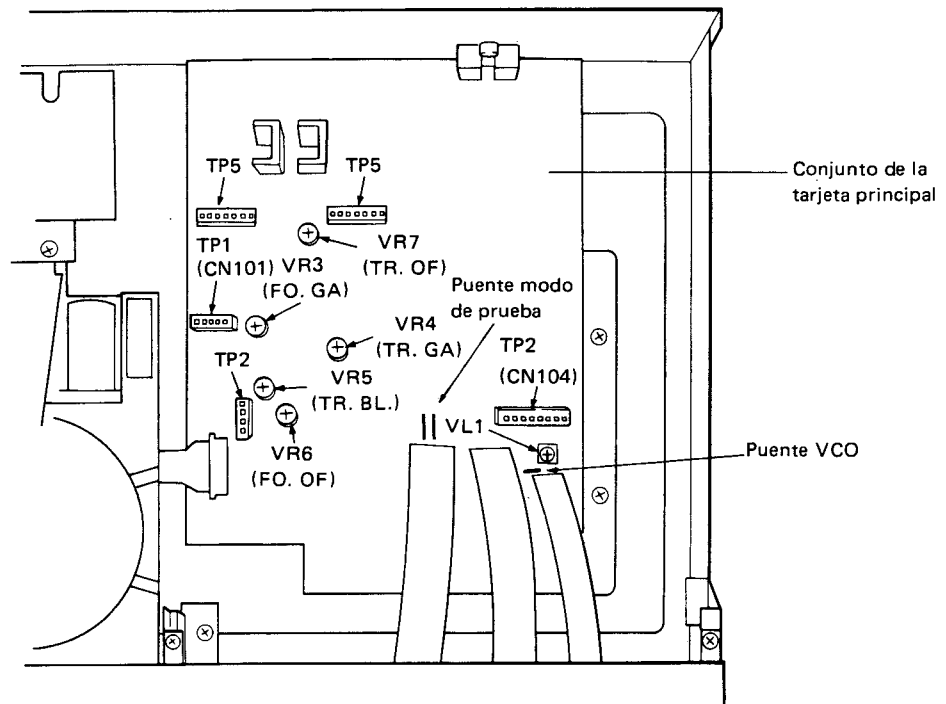
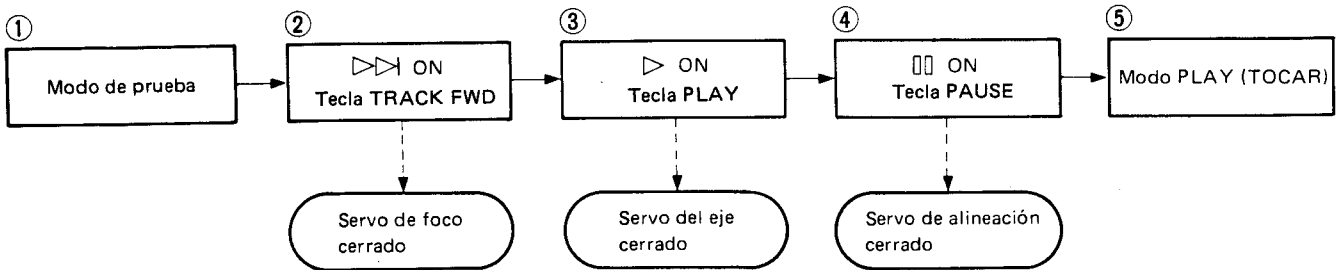

Fig. 9-1 Puntos de ajuste

Durante el modo de prueba cada mecanismo servo puede ser abierto o cerrado mediante operaciones separadas. En consecuencia cada servo debe ser cerrado, de a uno a la vez (en secuencia

serial) para regular el modo tocar. Notar que el modo tocar no se activa por la simple presión de la tecla PAUSE (PAUSA) (⏸) durante el modo de prueba.

Ejemplo: Cambiar desde el modo detenido al modo tocar.



- Chaque servomécanisme du mode d'essai a lieu dans l'ordre séquentiel.

• Funciones de teclas en el modo de prueba

Tabla 9-1 Funciones de teclas

Símbolo	Tecla	Función durante el modo de prueba	Descripción
⏮	TRACK BACK	Diodo laser activado	Orificio de ajuste de graduación
⏭	TRACK FWD (ALINEACION HACIA ADELANTE)	El servo del foco se cierra.	El diodo láser se enciende, el accionador del foco se mueve hacia arriba/abajo, y el servo del foco se cierra.
▶	PLAY (TOCAR)	El servo del eje se cierra.	El servo del eje se cierra en el modo CLV-A después que el motor de la aguja es arrancado.
⏸	PAUSE (PAUSA)	Servo de alineación cerrado/abierto.	El servo de alineación se cierra presionandolo por palanca, y el tocadiscos es puesto en el modo tocar (con los servos de foco y eje cerrados). El indicador PAUSE se enciende y el servo de alineación se abre al presionarlo por segunda vez.
⏪	MANUAL SEARCH REV (BUSQUE MANUAL EN REVERSA)	El carro se devuelve (hacia el centro del disco).	El carro se mueve hacia el centro del disco a una velocidad rápida de aproximadamente 1 cm/seg. Como no existe mecanismo de seguridad para detener el carro, cuidese de no moverlo demasiado hacia el centro.
⏩	MANUAL SEARCH FWD (BUSQUEDA MANUAL HACIA ADELANTE)	El carro se mueve hacia adelante (hacia el borde del disco).	El carro se mueve hacia el borde del disco a una velocidad rápida de aproximadamente 1 cm/seg. Como no existe mecanismo de seguridad para detener el carro, cuidese de no moverlo demasiado hacia el centro.
□	REPEAT (REPETIR)	El lente se mueve hacia arriba/abajo.	El diodo láser se enciende y el accionador del foco se mueve hacia arriba/abajo. No se cierra el cervo del foco.
□	STOP (PARAR)	Parar.	Todos los servos se detienen y se recolocan en su estado inicial.
⏴	CERRADO/ABIERTO	(Bandeja de discos) abierta/cerrada.	La bandeja de discos está abierta/cerrada. Notar que el brazo de fonocaptor no regresa al soporte del brazo cuando la bandeja se abre, y permanece en la misma posición al cerrar la bandeja.

No. de paso	Posición del osciloscopio		Puntos de chequeo	Posiciones de ajuste	Items de verificación/ Especificaciones de ajuste	Procedimiento de ajuste
	V	H				
1 AJUSTES DE DESALINEACION Y DESENFUQUE						
			TP1 Pasador 2 (TR.RT)	VR 7 (TR. OF)	0V ± 10mV	<ul style="list-style-type: none"> • Poner el tocadiscos en el modo de prueba (véase la página 59). • Ajustar la tensión en el TP1 pasador 2 TR.RT (retorno de alineación) en 0 V ± 10 mV girando el control VR7 TR.OF (desalineación). • Colocar el medidor de energía óptica directamente sobre el objetivo y verificar que la energía LD satisfice las condiciones nominales especificadas. <p><i>Nota: Cuando ajuste VR7, tenga cuidado de no cortocircuitarlo con el disipador térmico de IC7 (como precaución, envuelva el destornillador con material aislante).</i></p>
			TP 1 Pasador 5 (FO.ER)	VR 6 (FO. OF)	0V ± 10mV	
2 VERIFICACION DE ENERGIA LD (DIODO LASER)						
				VR1	Condiciones nominales especificadas (0.21mW ± 0.02mW)	<ul style="list-style-type: none"> • Régler en mode d'essai (voir page 59). • Appuyer sur la touche TRACK, et allumer la DL (diode au laser) • Placer le senseur du compteur de puissance du système optique directement au-dessus de la lentille de l'objectif et vérifier si la puissance de la DL est de la valeur standard (0,21 mW ± 0,02 mW). • Si la puissance de la DL n'est pas de la valeur standard, l'ajuster à l'aide du réglage d'intensité de puissance de DL (à l'intérieur de l'assemblage du capteur). • Après avoir réglé la puissance de la DL, reproduire un disque étalon (YEDS7) et mesurer la tension de crête à crête de la forme d'onde RF. • Si la tension de crête à crête de la forme d'onde RF dépasse 1,5 V, ajuster la puissance de la DL de façon à obtenir une tension de crête à crête de 1,5 V environ.
3 VERIFICACION DEL SEGURO DEL FOCO Y DEL FOCO DE LA AGUJA						
	V 0.5V/div.	H 100 mseg/div	TF2 Pasador 1 (salida RF)		Salida RF generada Rotación normal	<ul style="list-style-type: none"> • Cargar el disco de prueba. • Colocar el tocadiscos en el modo de prueba (véase la página 59). • Presionar la tecla MANUAL SEARCH FWD para mover el fonocaptor a aproximadamente el centro del disco. Nótese que este paso debe ser ejecutado. • Observar TP2 pasador 1 RF (salida RF) mediante el osciloscopio para verificar si se genera una señal de salida RF cuando se presiona tecla TRACK FWD (▷▷). • Presionar la tecla PLAY (▷) y verificar que el disco gira a velocidad normal (aproximadamente 300 rpm cerca del centro del disco) en la dirección correcta (en el sentido de los punteros del reloj).

No. de paso	Posición del osciloscopio		Puntos de chequeo	Posiciones de ajuste	Items de verificación/ Especificaciones de ajuste	Procedimiento de ajuste
	V	H				

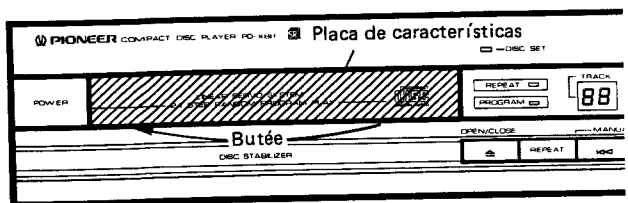

Extraiga la placa de características.

Fig. 9-2

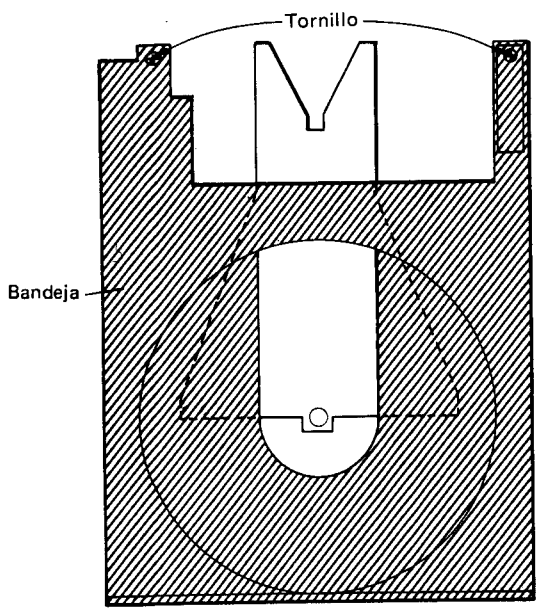

Extraiga los dos tornillos que aseguran la bandeja del disco, y tire de dicha bandeja hacia afuera.

Fig. 9-3

- Realice este ajuste después de haber extraído la bandeja del disco.
 - Extracción de la bandeja del disco
1. Conecte la alimentación, y tire hacia afuera de la bandeja del disco.
 2. Extraiga los dos tornillos inferiores y tire hacia arriba de la placa de características para extraerla. (Fig. 9-2)
 3. Extraiga el panel frontal.
 4. Extraiga los dos tornillos que aseguran la bandeja del disco y la unidad base deslizante. (Fig. 9-3)
 5. Tire hacia afuera de la bandeja, la placa, y la leva de la correa junto con la unidad del riel deslizante. (Fig. 8-3)
 6. La fotografía 9-1 muestra la unidad después de haber extraído la bandeja del disco siguiendo los pasos 6.1 a 6.5.
- Ahora podrá realizar el ajuste de cuadrícula.

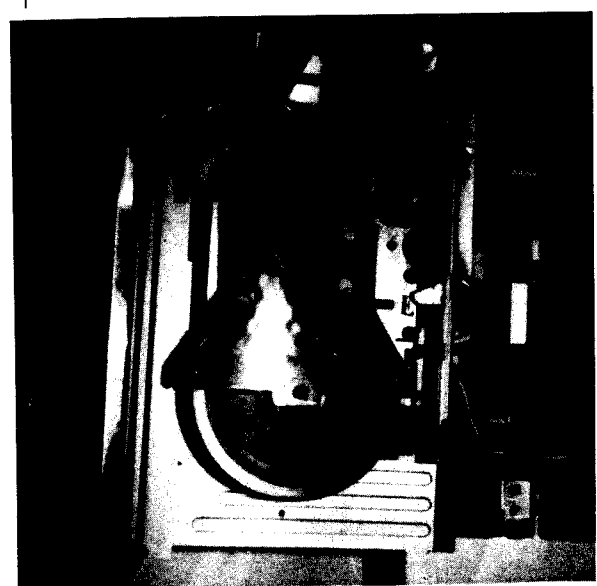

Fotografía 9-1 Con la bandeja del disco extraída

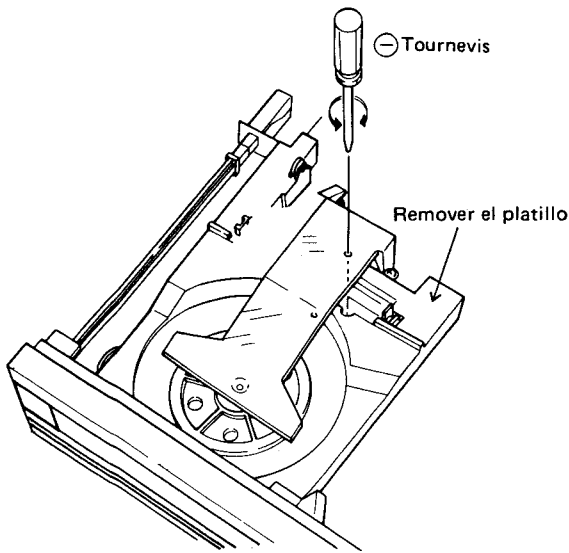
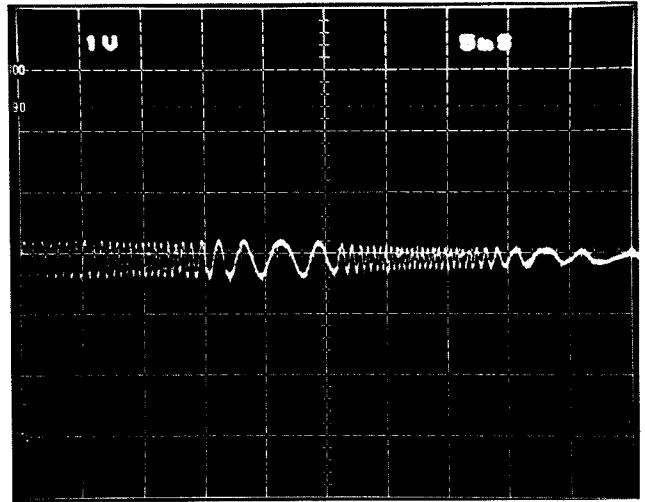
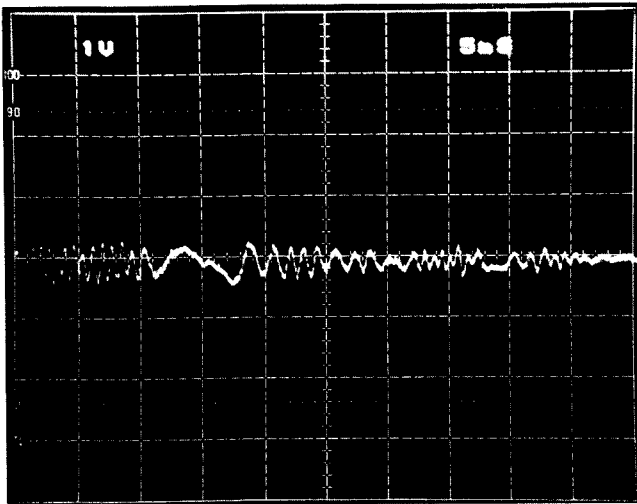

Fig. 9-6 Ajuste de mira



Fotografía 9-2 Punto NULL



Fotografía 9-3 Forma de onda más allá del punto NULL

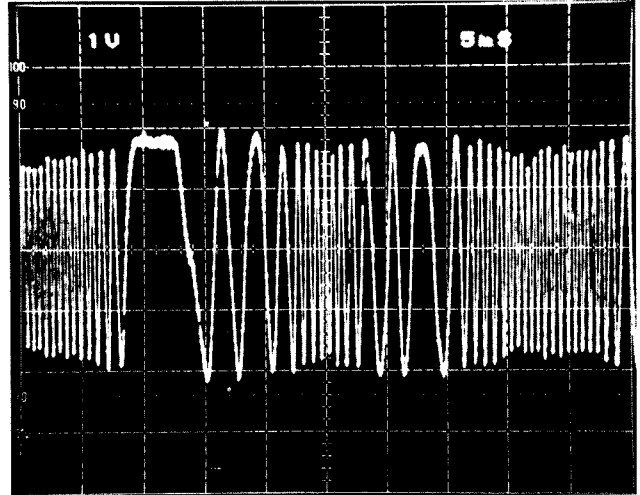

Fotografía 9-4 Amplitud máxima

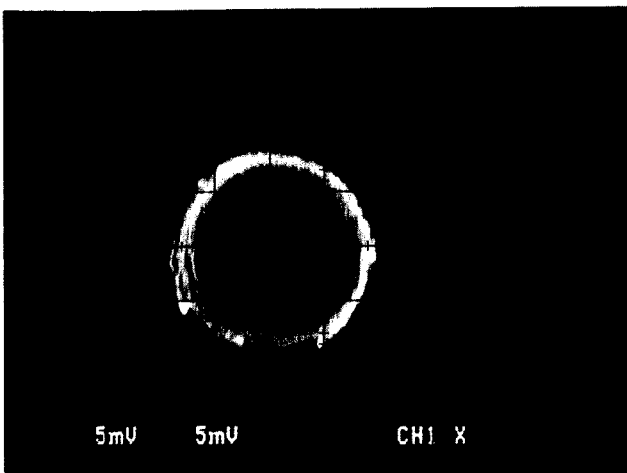

Fotografía 9-5

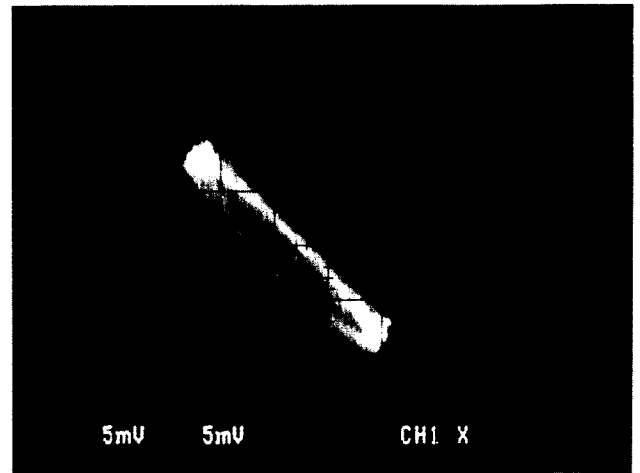

Fotografía 9-6

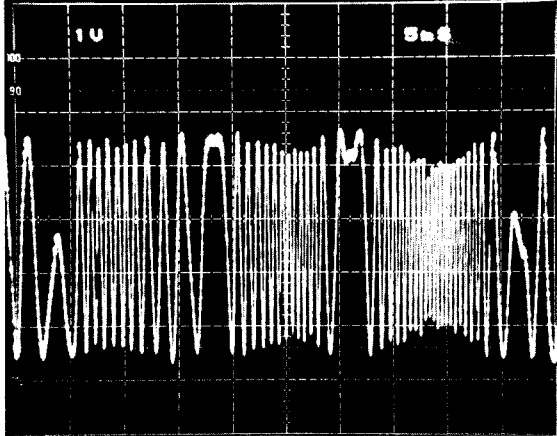
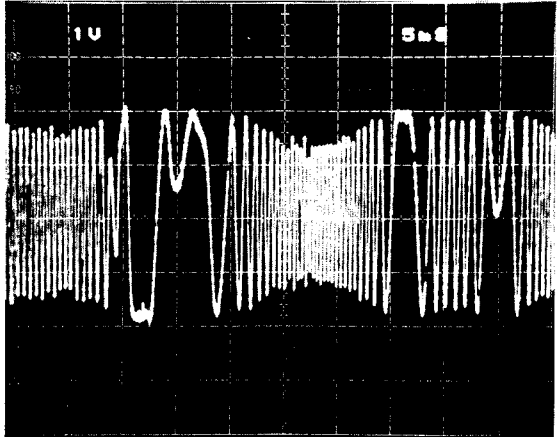
No. de paso	Posición del osciloscopio		Puntos de chequeo	Posiciones de ajuste	Items de verificación/ Especificaciones de ajuste	Procedimiento de ajuste
	V	H				
5	AJUSTE DE EQUILIBRIO DE ALINEACION					
	1 V/div.	5 mseg/div.	TP1 pasador 4 (TR,ER)	VR 5 (TR,BL)		<ul style="list-style-type: none"> • Cargar el disco de prueba. • Poner el tocadiscos en el modo de prueba (véase la página 59). • Mueva el carro a una posición cerca del centro del disco usando la tecla MANUAL SEARCH FWD (▷▷). • Presionar la tecla TRACK FWD (▷▷) y luego la tecla PLAY (▷) para que el disco comience a girar. • Observar TP1 pasador 4 TR,ER (error de alineación) en el osciloscopio y eliminar el componente de C.C. del error de alineación ajustando el control VR5 TR.BL (equilibrio de alineación).
						 <p>Fotografía 9-10 Componentes de C.C. incluidos</p>  <p>Fotografía 9-11 Componentes de C.C. excluidos</p>

No. de paso	Posición del osciloscopio		Puntos de chequeo	Posiciones de ajuste	Items de verificación/ Especificaciones de ajuste	Procedimiento de ajuste
	V	H				
6	AJUSTE TANGENCIAL					
			200nS TP2 Pasador 1 (Salida RF)	Tornillo de ajuste tangencial	Mejor patrón de vista	<ul style="list-style-type: none"> • Cargar el disco de prueba. • Colocar el tocadiscos en el mode de prueba (véase la página 59). • Mover el fonocaptor al borde del disco usando la tecla MANUAL SEARCH FWD (>), para permitir que el tornillo de ajuste tangencial se vea desde el lado izquierdo (véase la Fig. 9-9). • Presionar las teclas TRACK FWD (>>), PLAY (>) y PAUSE (00) para cerrar todos los servos. (Se encenderá el indicador de pausa.) • Observar el TP2 pasador 1 RF (salida RF) en el osciloscopio, y ajustar mediante el tornillo de ajuste tangencial para obtener el patrón de vista más claro. (Fig. 9-9). • La posición óptima es el punto medio entra las dos posiciones donde el patrón de vista comienza a deteriorarse cuando el tornillo de ajuste tangencial se gira en el sentido de los punteros de reloj y en el sentido contrario. Guías para el ajuste: Además de una formade onda general clara, se debe ajustar para obtener líneas relativamente finas (véase la fotografía 9-12), donde se observan formas de "diamante" simple en el patrón de vista. • Para facilitar la observación de la forma de onda más fácil de observar, insertar una resistencia de 10 Kohm (o 5 Kohm si la forma de onda es difícil de distinguir) en la punta del probador, como se indica en la Fig. 9-8).
						<p style="text-align: center;">Fig. 9-8</p> <p><i>Nota: Para realizar los ajustes, levante ligeramente la unidad captora con una llave hexagonal de forma que no pueda caerse.</i></p> <p style="text-align: center;">Llave de tubo hexagonal Pick-up</p>

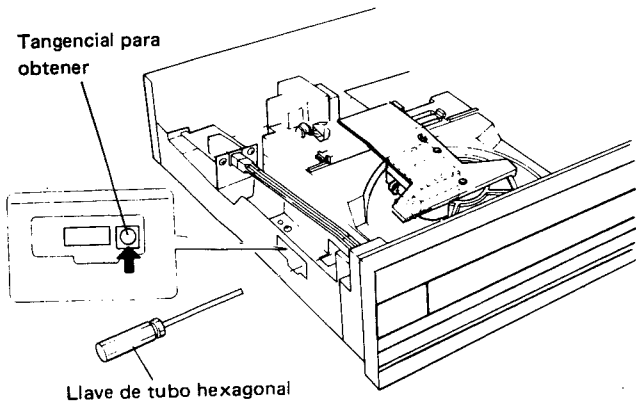
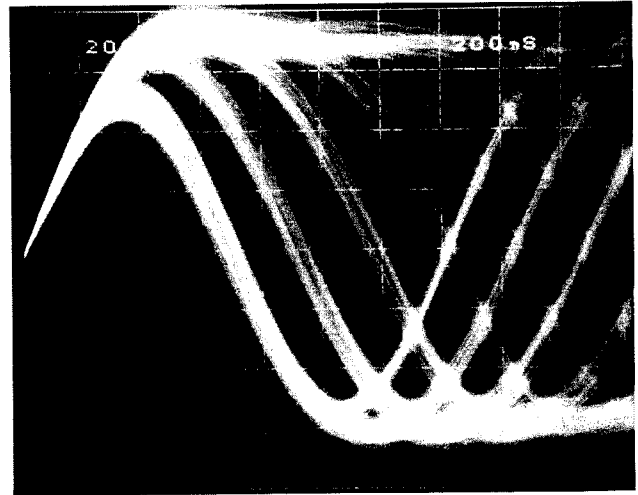
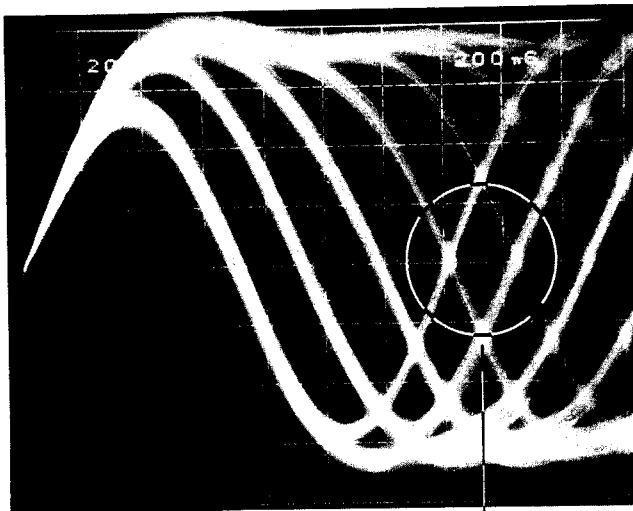

Fig. 9-9 Ajuste tangencial



Fotografía 9-13



Point d'observation

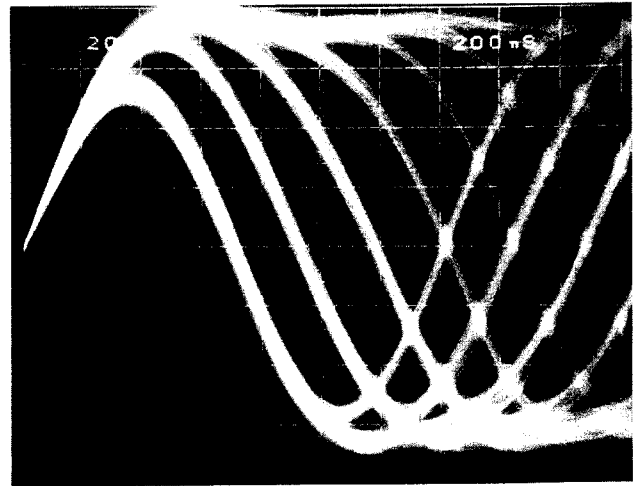

Fotografía 9-14

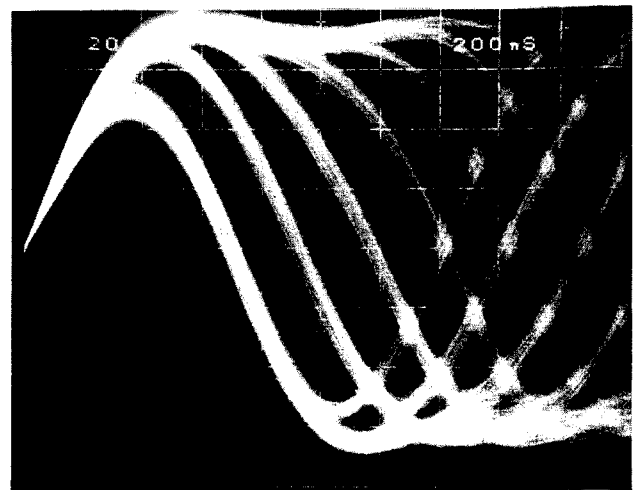

Fotografía 9-15

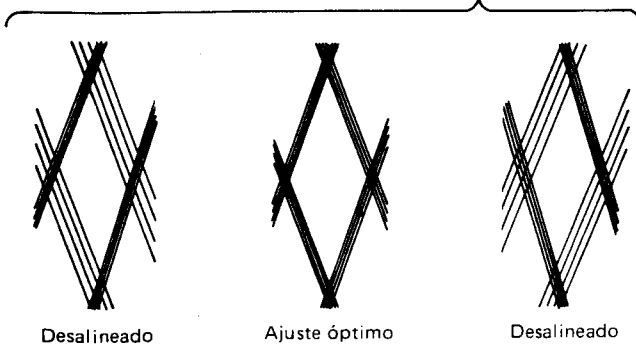

Fotografía 9-12

No. de paso	Posición del osciloscopio		Puntos de chequeo	Posiciones de ajuste	Items de verificación/ Especificaciones de ajuste	Procedimiento de ajuste
	V	H				
7	AJUSTE DE GANANCIA DE FOCO					
	20mV/div./5mV/div. Canal1(X), Canal2(Y) (Sonda 10 : 1)		Eje X TP 5 Pasador 1 (FO. IN) Eje Y TP 5 Pasador 2 (FO. OT)	VR 3 (FO. GA)	Diferencia de fase de 90°	<ul style="list-style-type: none"> Desconecte la alimentación, y conecte el osciloscopio y el oscilador como se muestra en la Fig. 9-10. Poner el tocadiscos en el modo de prueba (véase la página 59). Presione, por este orden, las teclas TRAC FWD, PLAY, y PAUSE. Active los servos para enfoque, el husillo, y seguimiento. Conecte la alimentación del oscilador y ajústelo a 875Hz, 0,5Vp-p. <p><i>Nota: Como se puede dar el caso de que al conectar la alimentación, el oscilador dé salida a CC, se aconseja conectar dicho oscilador después de haber conectado la alimentación.</i></p> <ul style="list-style-type: none"> Ajuste la forma de onda de Lissajous del osciloscopio hasta obtener el círculo (90° de diferencia de fase) mostrado en la fotografía 9-17. Después ajuste el control de VR3 FO GA (ganancia de enfoque).

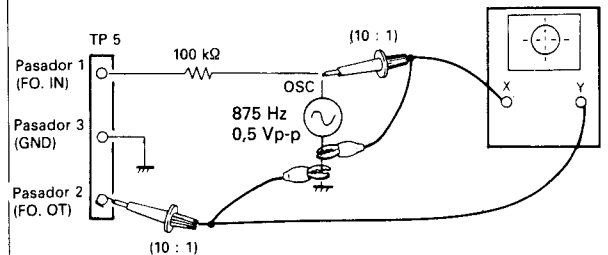
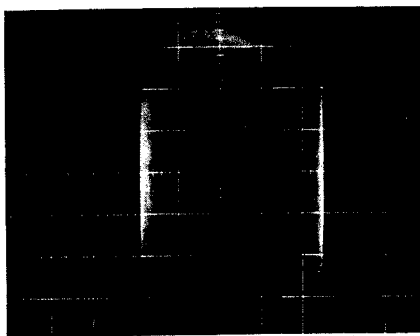
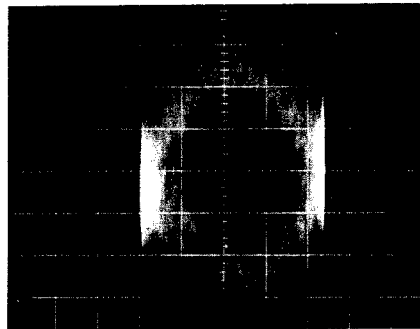

Fig. 9-10 Conexión del osciloscopio a un oscilador



Fotografía 9-16
Ganancia demasiado grande



Fotografía 9-17 Ganancia ideal

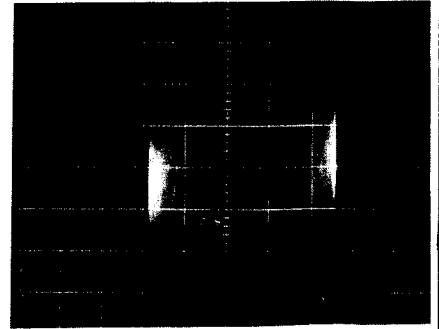

Fotografía 9-18
Ganancia demasiado pequeña

No. de paso	Posición del osciloscopio		Puntos de chequeo	Posiciones de ajuste	Items de verificación/ Especificaciones de ajuste	Procedimiento de ajuste
	V	H				
8	AJUSTE DE GANANCIA DE ALINEACION					
						<ul style="list-style-type: none"> • Desconecte la alimentación, y conecte el osciloscopio y el oscilador como se muestra en la Fig. 9-11. • Colocar el tocadiscos en el modo de prueba (véase página 59). • Presione, por este orden, las teclas TRAC FWD, PLAY, y PAUSE. Active los servos para enfoque, el husillo, y seguimiento. • Conecte la alimentación del oscilador y ajústelo a 800Hz 0,5Vp-p. <p><i>Nota: Como se puede dar el caso de que al conectar la alimentación, el oscilador dé salida a CC, se aconseja conectar dicho oscilador después de haber conectado la alimentación.</i></p> <ul style="list-style-type: none"> • Ajuste la forma de onda de Lissajous del osciloscopio hasta obtener el círculo (90° de diferencia de fase) mostrado en la fotografía 9-20. Después ajuste el control de VR4 TR GA (ganancia de alineación).
	50mV/div./10mV/div. Canal1(X), Canal2(Y) (Sonda 10 : 1)		Eje X TP 5 Pasador 4 (TR. IN) Eje Y TP 5 Pasador5 (TR. OT)	VR-4 (TR. GA)	Diferencia de fase de 90°	

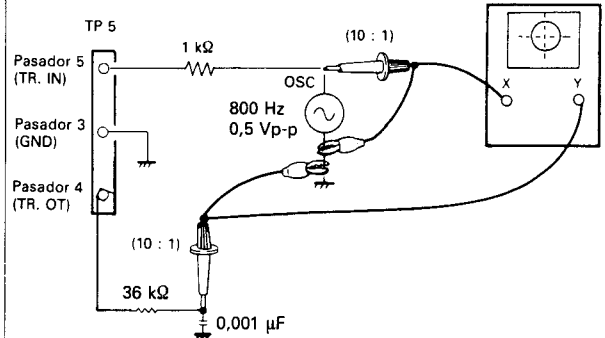
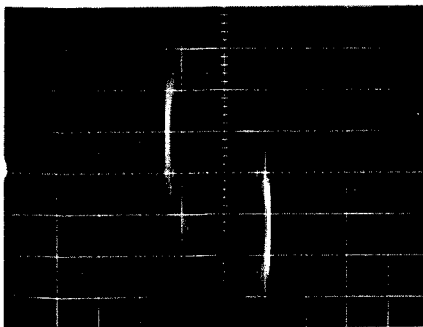
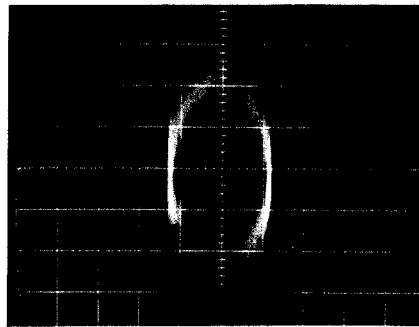

Fig. 9-11 Conexión del osciloscopio a un oscilador



Fotografía 9-19
Ganancia demasiado grande



Fotografía 9-20 Ganancia ideal

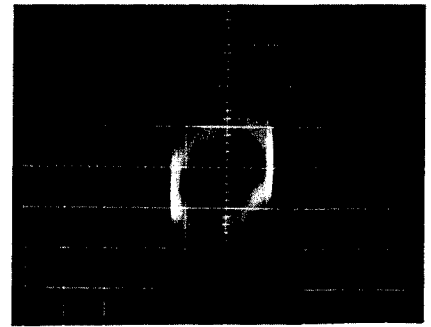

Fotografía 9-21
Ganancia demasiado pequeña

No. de paso	Posición del osciloscopio		Puntos de chequeo	Posiciones de ajuste	Items de verificación/ Especificaciones de ajuste	Procedimiento de ajuste
	V	H				
9	AJUSTE DE FRECUENCIA DE OPERACION LIBRE VCO					
	0,5 V/div	5mS/div.	Puente VCO TP		Escribir el valor medio de la forma de la curva	<ul style="list-style-type: none"> • Inserte un disco de prueba. • Colocar el tocadiscos en el modo de prueba (véase la página 59). • Presionar las teclas TRACK FWD (▷) y PLAY (▷) en el orden para cerrar los servos de foco y del eje. • Después observe la forma de onda del hilo de puente VCO TP con un osciloscopio. (V : 0,5V/div.) • C47, R83, R87, etc., están conectados a la patilla 7, pero es más fácil de observar si se mide en el terminal de C47. • Anote el valor dental de la forma de onda del hilo de puente VCO TP. • Usando un colocador de núcleo, ajustar el núcleo VL1 (bobina VCO) de manera que el valor medio de la forma de onda del osciloscopio sea el mismo que el valor registrado previamente cuando la tecla PAUSE fue presionada para encender el servo de alineación.
	0.5V/div	5mS/div.	Puente VCO TP	Bobina VL 1 (VCO)		

10. FOR HB AND SD TYPES

The PD-X88/HB and SD types are the same as the PD-X88/HEM type with the exception of the following sections.

Mark	Symbol & Description	Part No.			Remarks
		PD-X88/HEM	PD-X88/HB	PD-X88/SD	
⚠	AC power cord	PDG1008	PDG1010	RDG1003	
⚠ *	Power transformer	PTT-270	PTT-270	PTT-271	
⚠ **	Line voltage selector	PSB1002	
	Operating instructions (English/German/French/Italian)	PRE1012	
	Operating instructions (English)	...	PRB1010	PRB1010	

10.1 SCHEMATIC DIAGRAM FOR HB TYPE

Line Voltage Selection

Line voltage can be changed with following steps.

1. Disconnect the AC power cord.
2. Remove the top cover.
3. Change the connection of the transformer board assembly Jamper wire.
4. Stick the line voltage label on the rear panel.

Part No.	Description
AAX-193	220V label
AAX-192	240V label

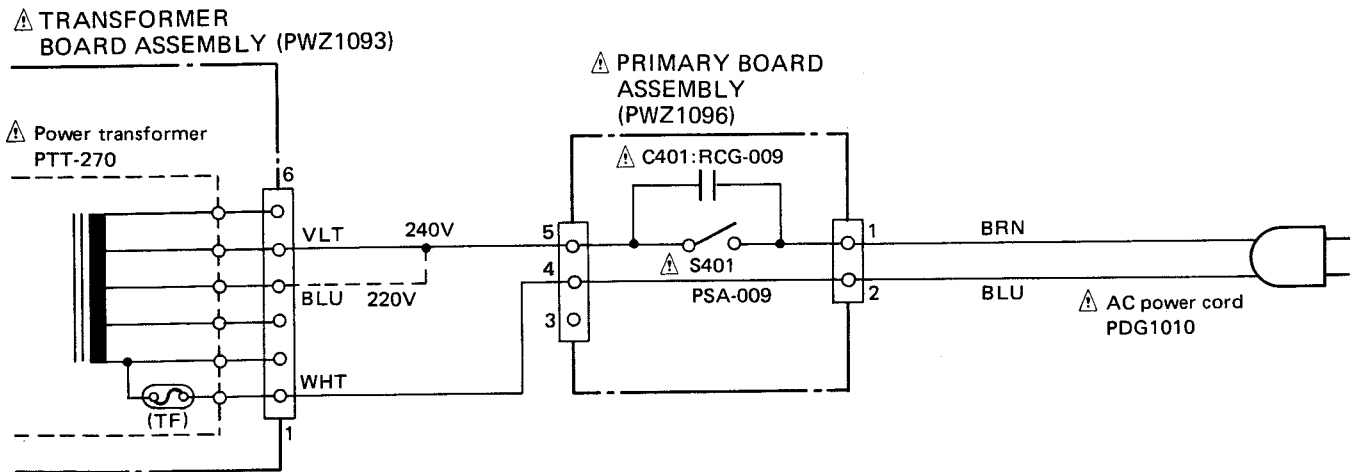

10.2 SCHEMATIC DIAGRAM FOR SD TYPE

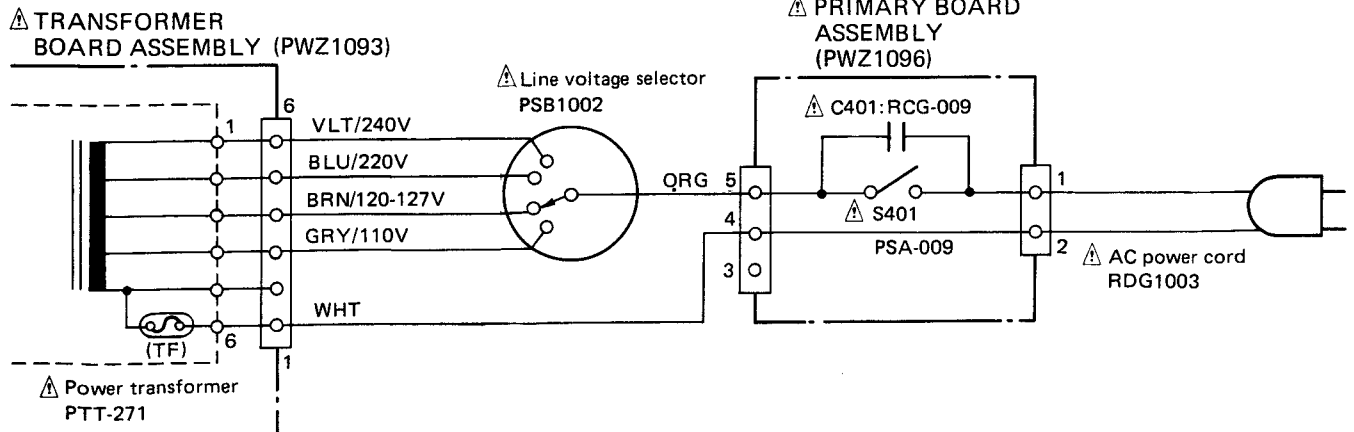

SAFETY INFORMATION

(FOR USA MODEL ONLY)

1. SAFETY PRECAUTIONS

The following check should be performed for the continued protection of the customer and service technician.

LEAKAGE CURRENT CHECK

Measure leakage current to a known earth ground (water pipe, conduit, etc.) by connecting a leakage current tester such as Simpson Model 229-2 or equivalent between the earth ground and all exposed metal parts of the appliance (input/output terminals, screwheads, metal overlays, control shaft, etc.). Plug the AC line cord of the appliance directly into a 120V AC 60Hz outlet and turn the AC power switch on. Any current measured must not exceed 0.5mA.

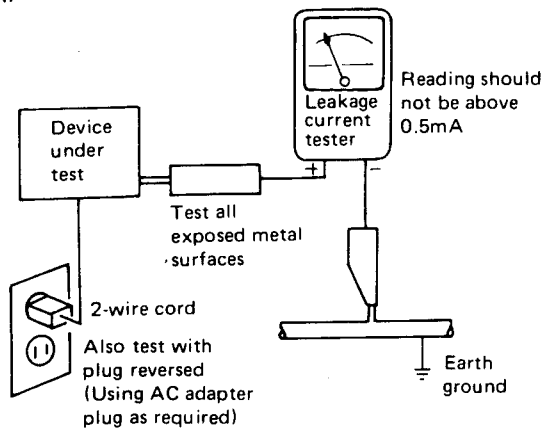

AC Leakage Test

ANY MEASUREMENTS NOT WITHIN THE LIMITS OUTLINED ABOVE ARE INDICATIVE OF A POTENTIAL SHOCK HAZARD AND MUST BE CORRECTED BEFORE RETURNING THE APPLIANCE TO THE CUSTOMER.

2. PRODUCT SAFETY NOTICE

Many electrical and mechanical parts in the appliance have special safety related characteristics. These are often not evident from visual inspection nor the protection afforded by them necessarily can be obtained by using replacement components rated for voltage, wattage, etc. Replacement parts which have these special safety characteristics are identified in this Service Manual.

Electrical components having such features are identified by marking with a Δ on the schematics and on the parts list in this Service Manual.

The use of a substitute replacement component which does not have the same safety characteristics as the PIONEER recommended replacement one, shown in the parts list in this Service Manual, may create shock, fire, or other hazards.

Product Safety is continuously under review and new instructions are issued from time to time. For the latest information, always consult the current PIONEER Service Manual. A subscription to, or additional copies of, PIONEER Service Manual may be obtained at a nominal charge from PIONEER.

(FOR EUROPEAN MODEL ONLY)

VAROITUS!

LAITE SISÄLTÄÄ LASERDIODIN, JOKA LÄHETTÄÄ NÄKYMÄTÖNTÄ, SILMILLE VAARALLISTA INFRAPUNASÄTEILYÄ LAITTEEN SISÄLLÄ ON LASERDIODIN LÄHEISYYDESSÄ KUVAN 1. MUKAINEN VAROITUSMERKKI.



LASER
Kuva 1
Lasersäteilyn
varoituserkki

WARNING!

DEVICE INCLUDES LASER DIODE WHICH EMITS INVISIBLE INFRARED RADIATION WHICH IS DANGEROUS TO EYES. THERE IS A WARNING SIGN ACCORDING TO PICTURE 1 INSIDE THE DEVICE CLOSE TO THE LASER DIODE.



LASER
Picture 1
Warning sign for
laser radiation

ADVERSEL:

USYNLIG LASERSTRÅLING VED ÅBNING NÅR SIKKERHEDSAFBRYDERE ER UDE AF FUNKTION UNGÅ UDSÆTTELSE FOR STRÅLING.

VIKTIGT

APARATEN INNEHÅLLER LASER AV HÖGRE KLASS ÄN 1. INGREPP I APPARATEN BÖR GÖRAS AV SPECIELLT UTBILDAD PERSONAL.

IMPORTANT

PIONEER COMPACT DISC PLAYER APPARATUS CONTAINS LASER OF HIGHER CLASS THAN 1. SERVICING OPERATION OF THE APPARATUS SHOULD BE DONE BY A SPECIALLY INSTRUCTED PERSON.

LABEL CHECK

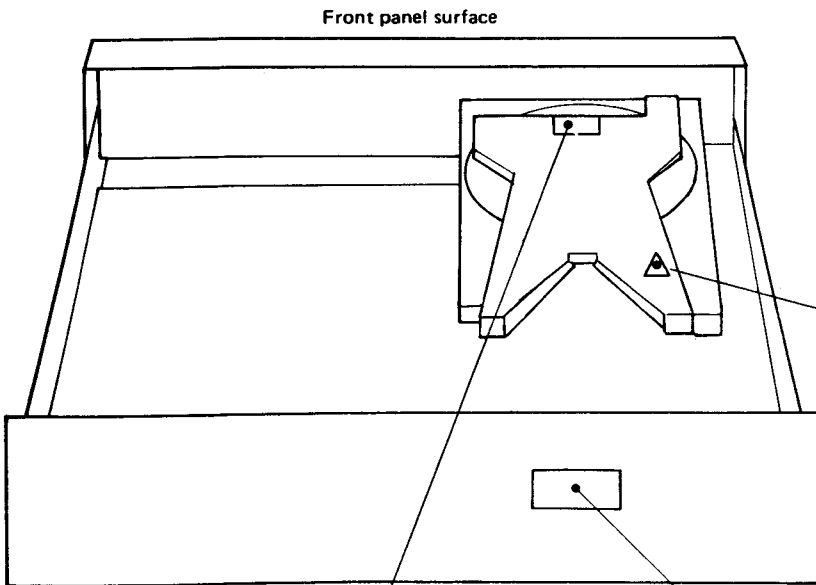
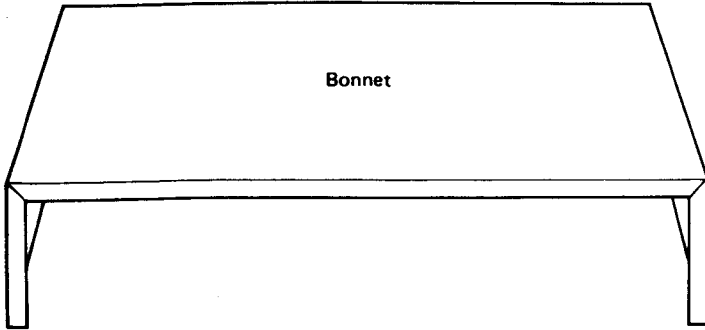

HEM and HB models



HB model

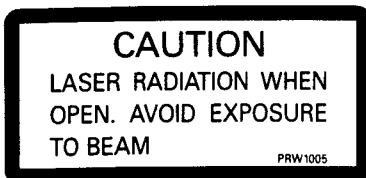

HEM and HB models



HEM model

